

Fig. 83

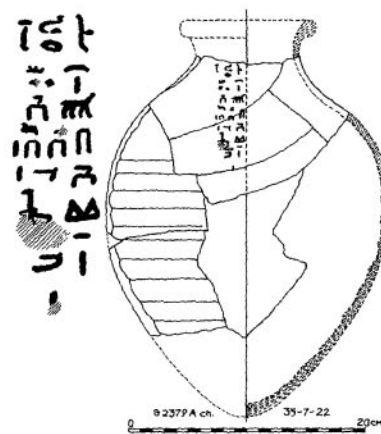

Fig. 84

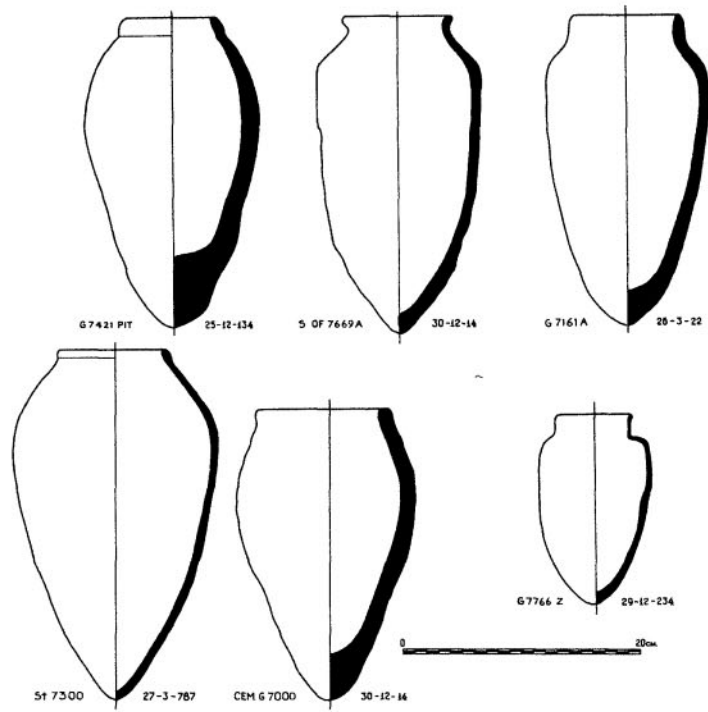

Fig. 85

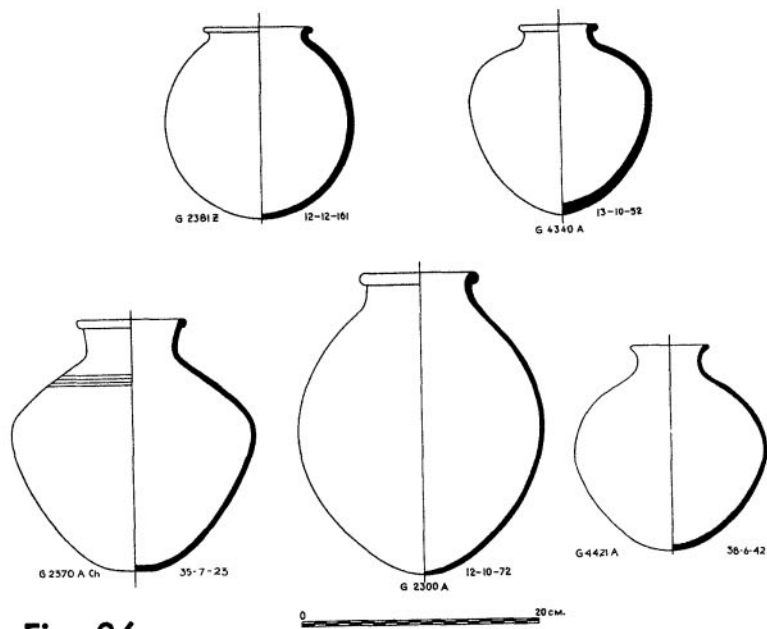

Fig. 86

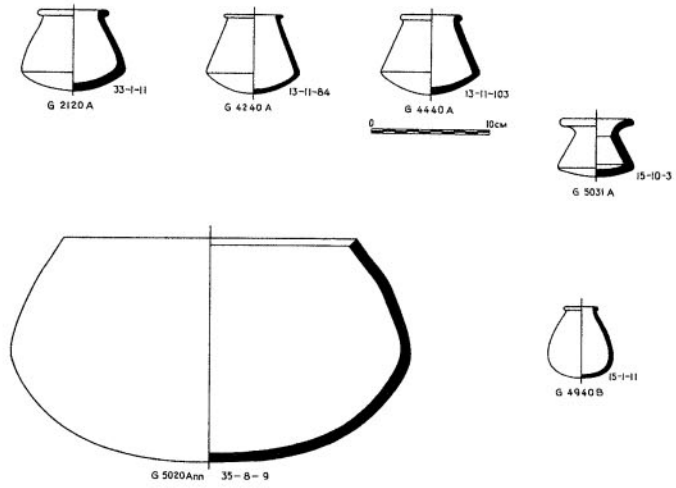

Fig. 87

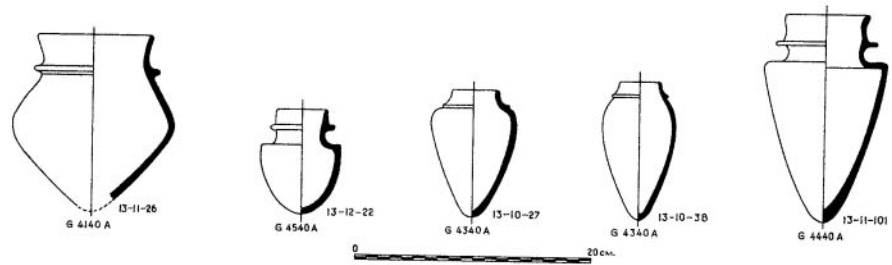

Fig. 88

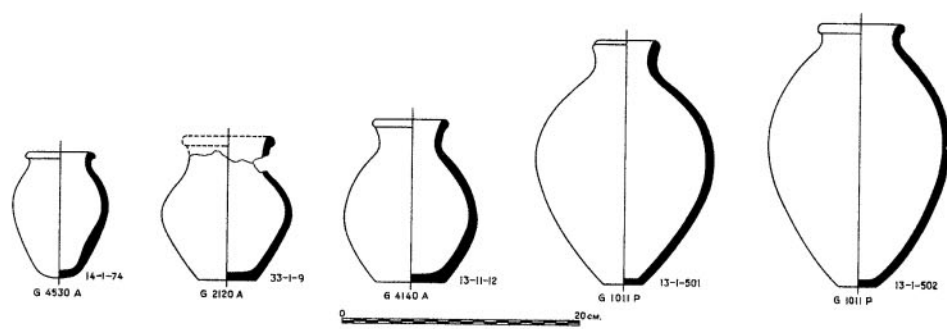

Fig. 89

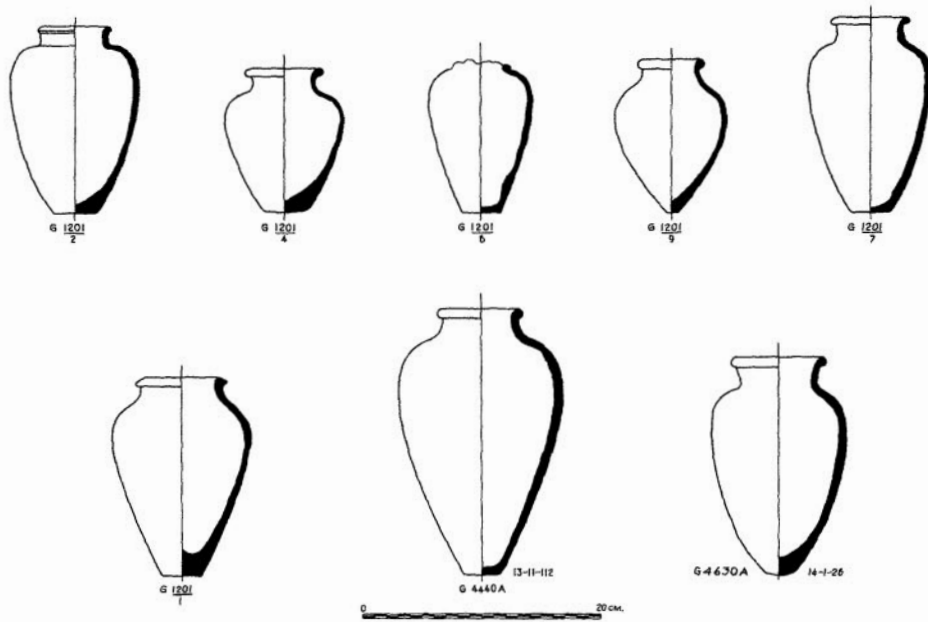

Fig. 90

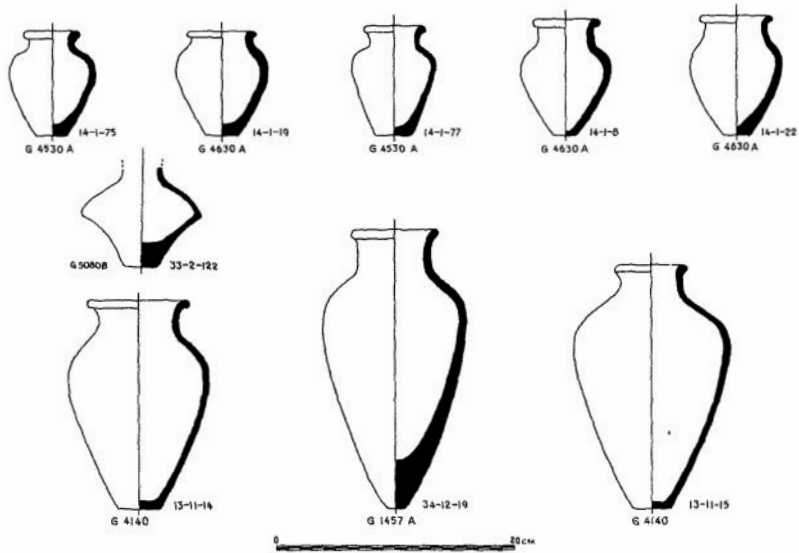

Fig. 91

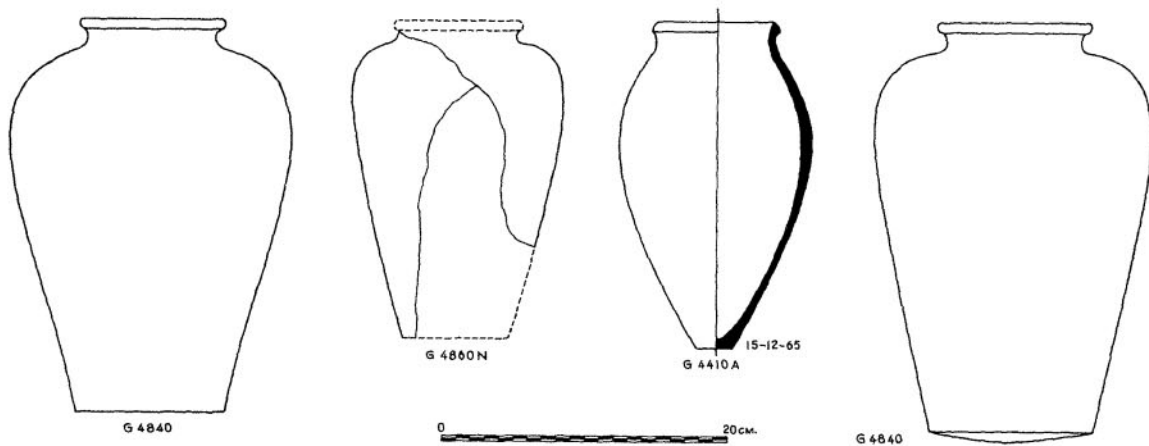

Fig. 92

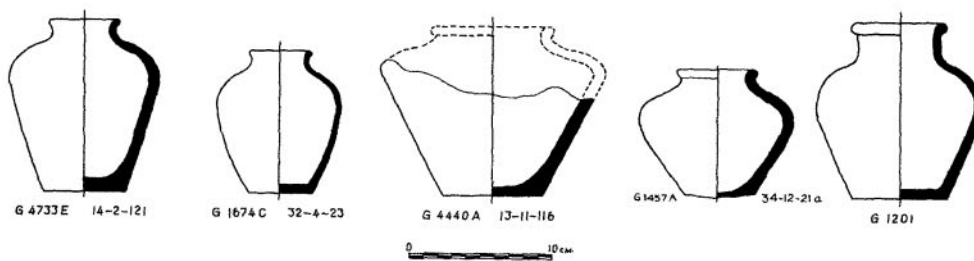

Fig. 93

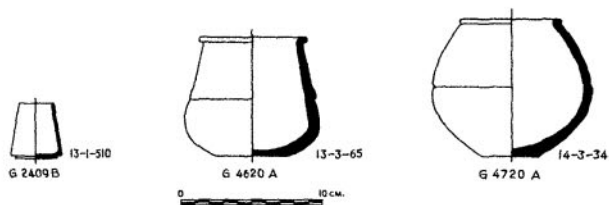

Fig. 94

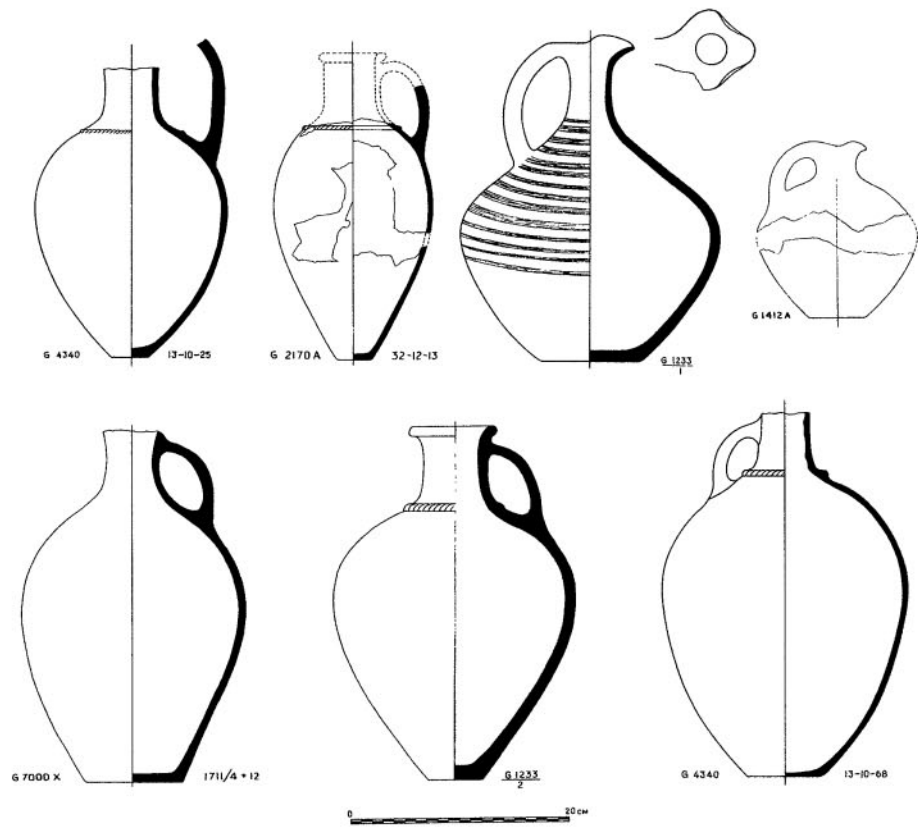

Fig. 95

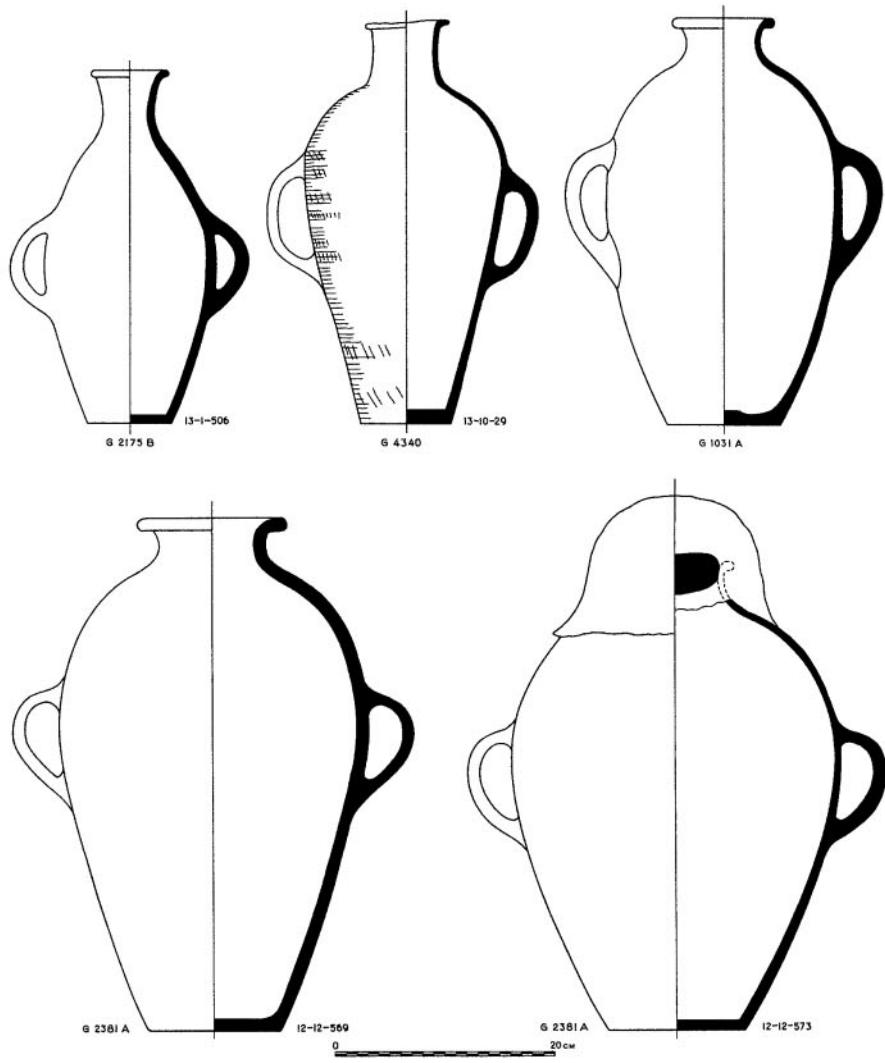

Fig. 96

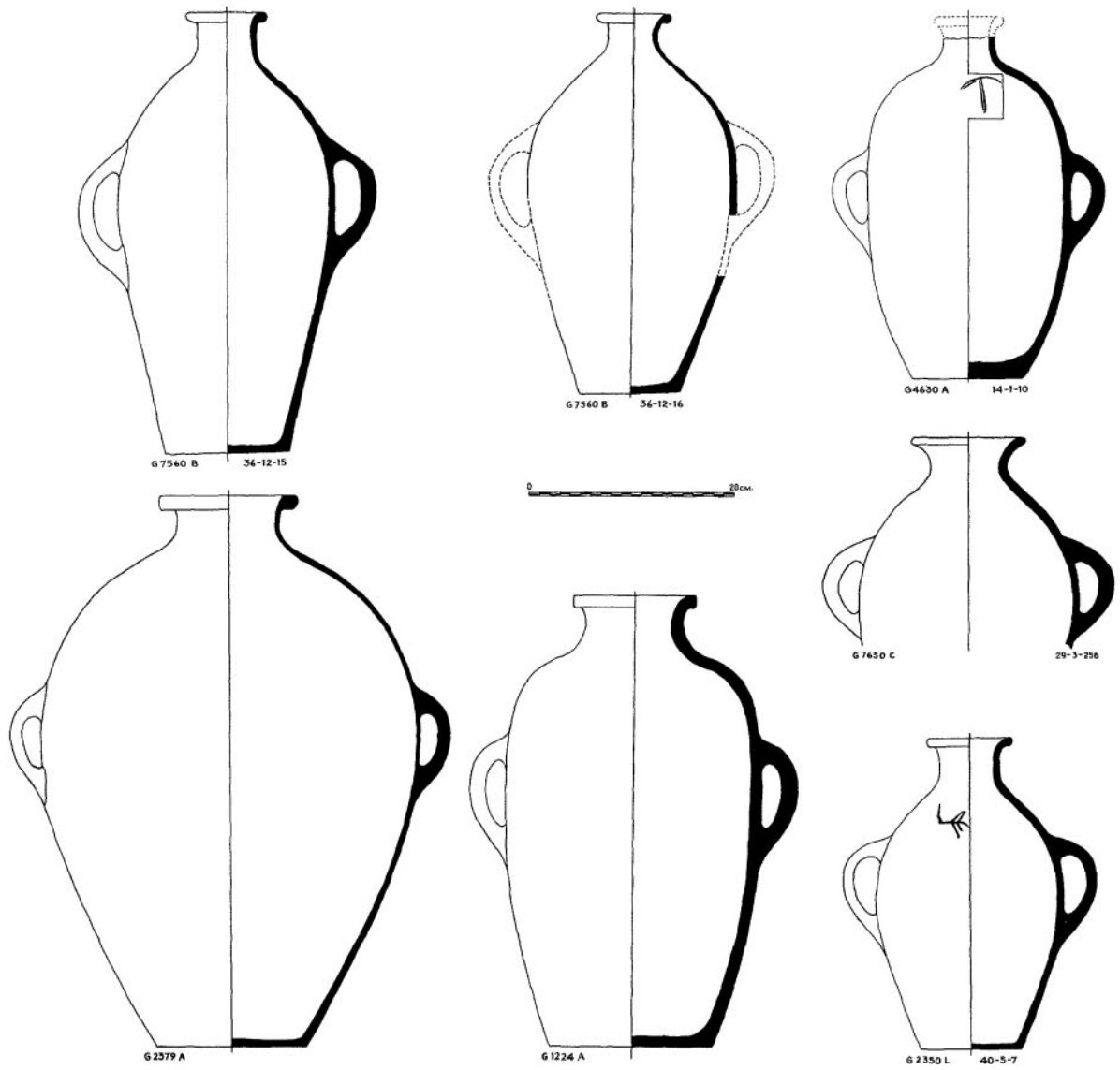

Fig. 97

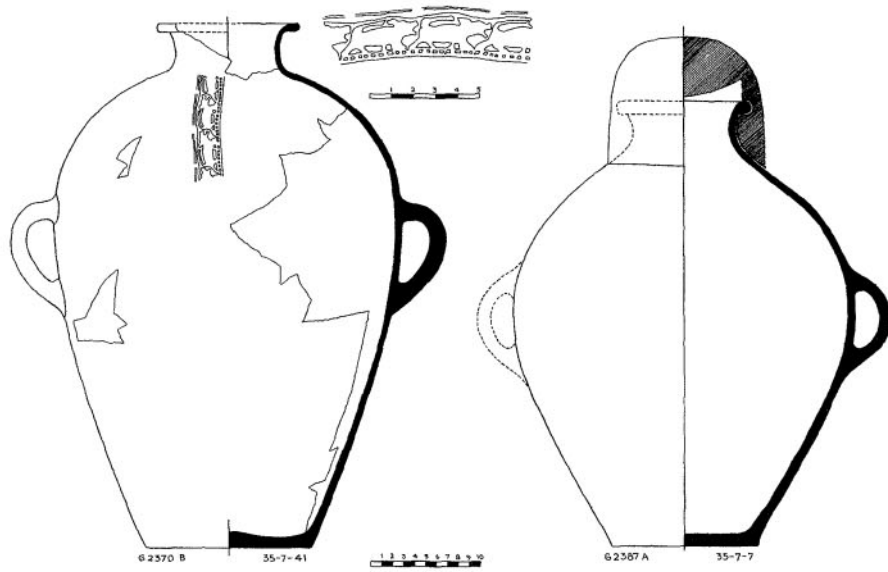

Fig. 98

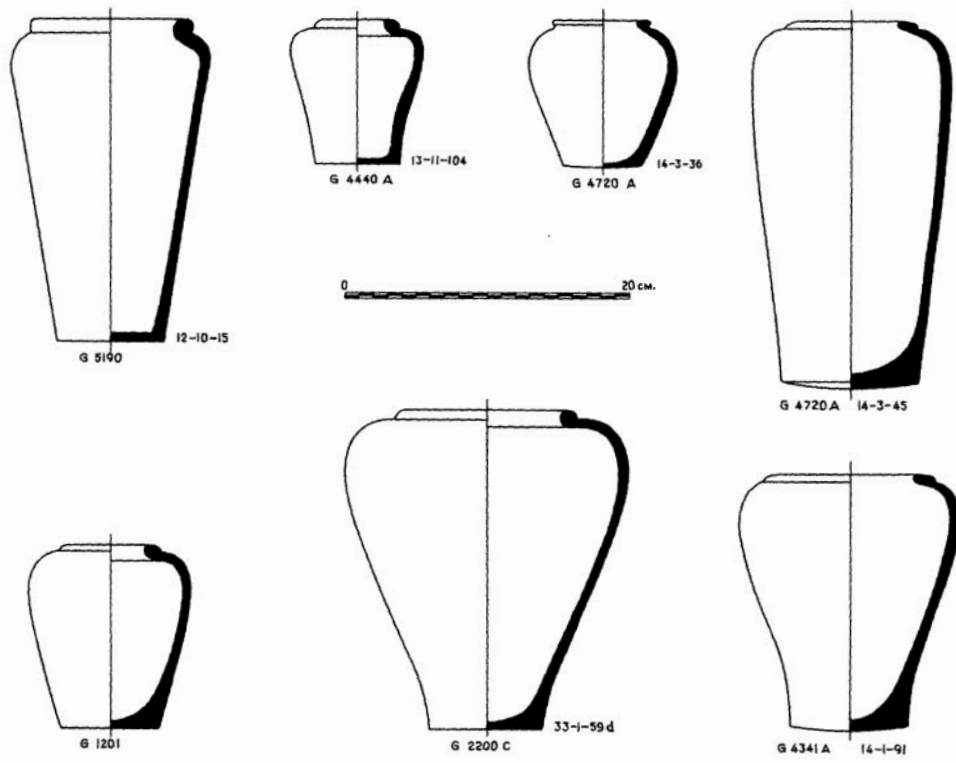

Fig. 99

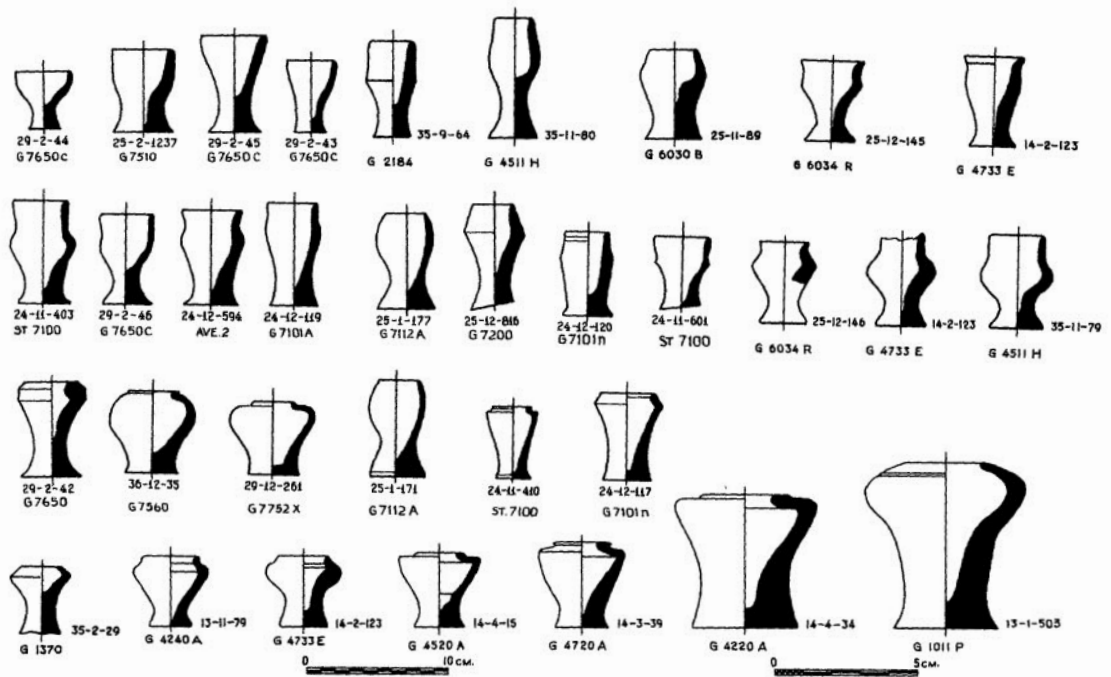

Fig. 100

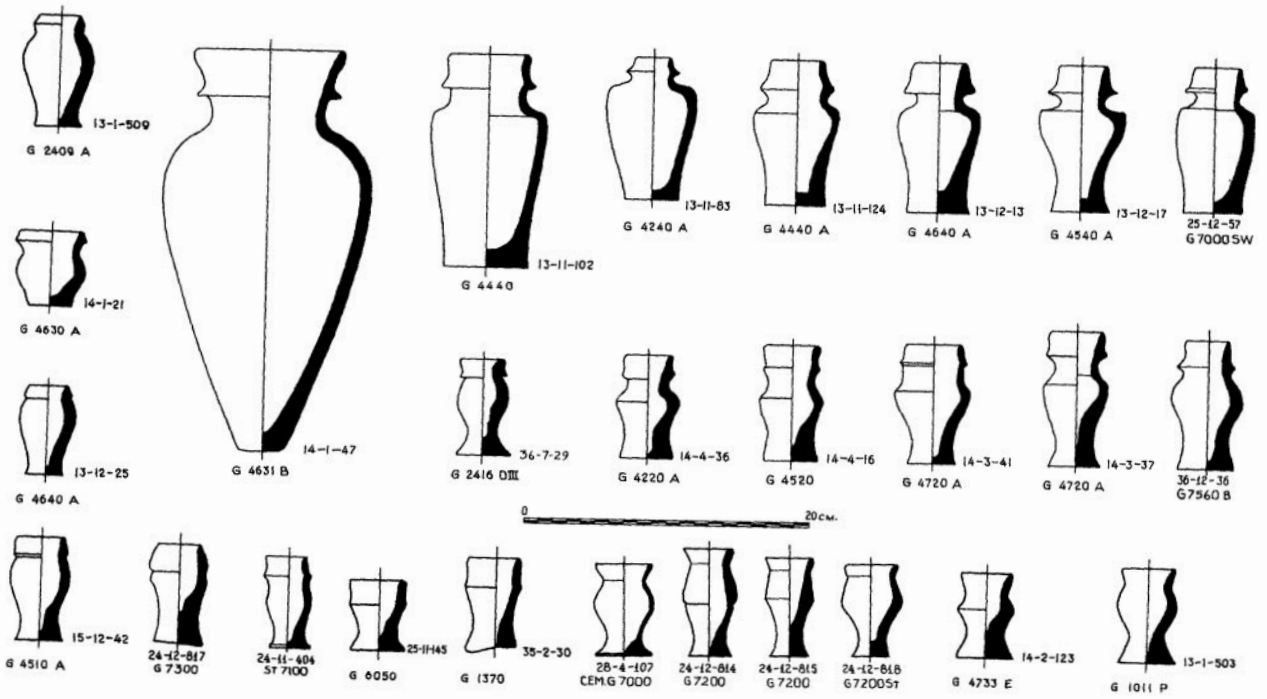

Fig. 101

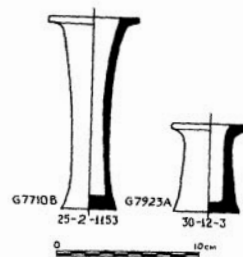

Fig. 102

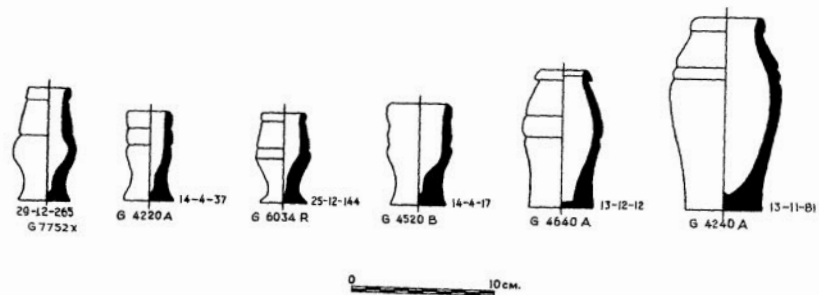

Fig. 103

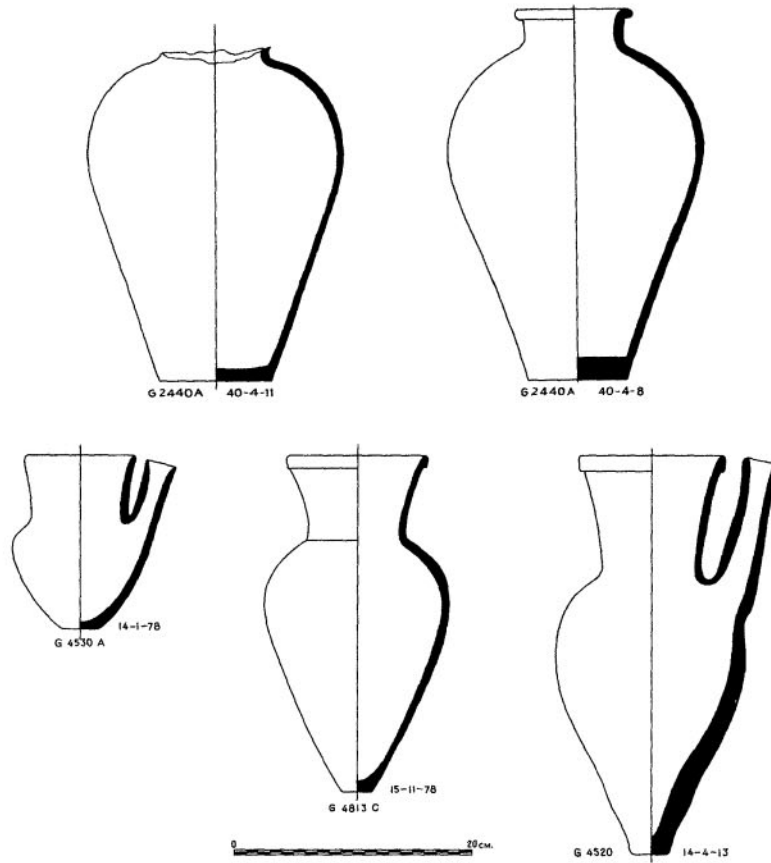

Fig. 104

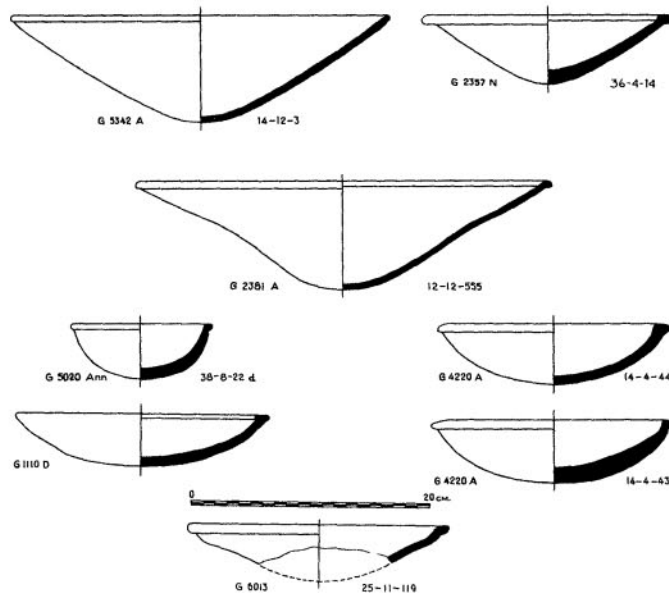

Fig. 105

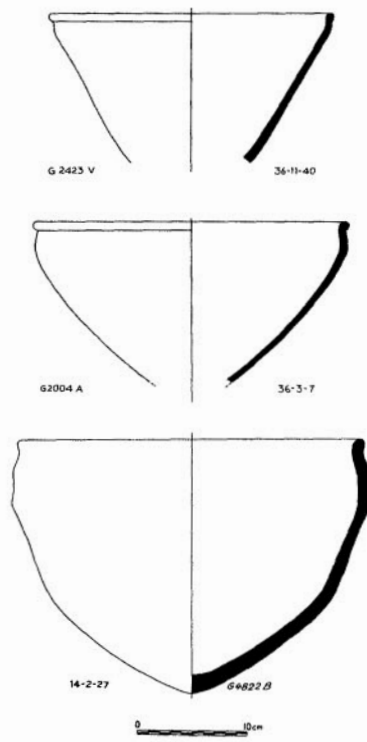

Fig. 106

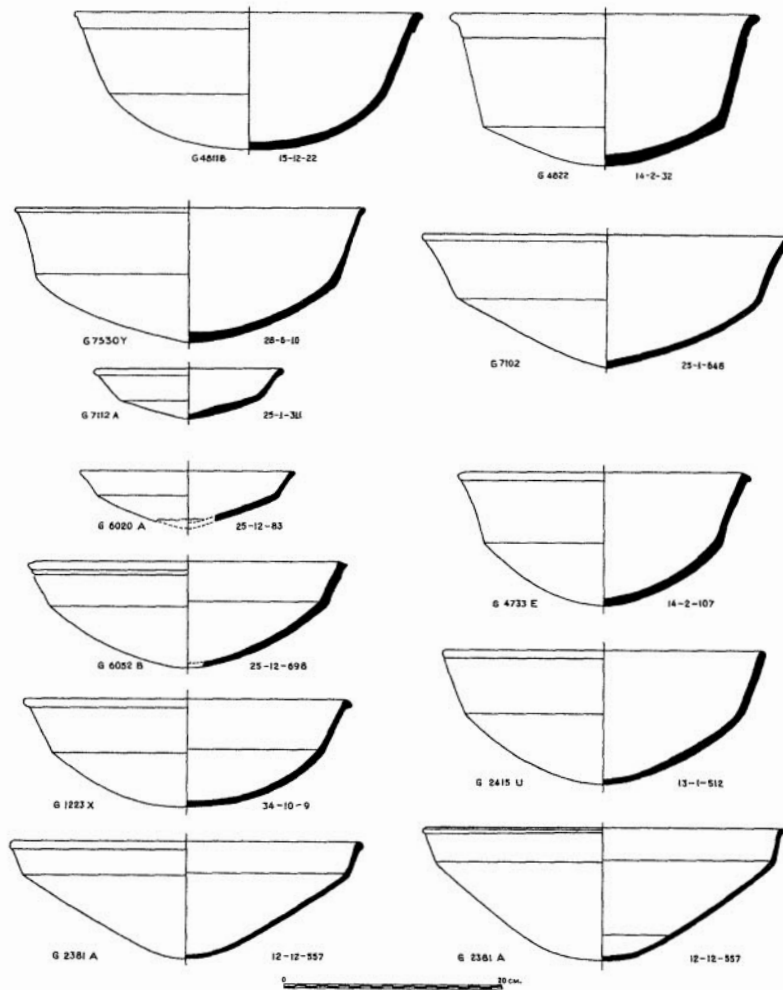

Fig. 107

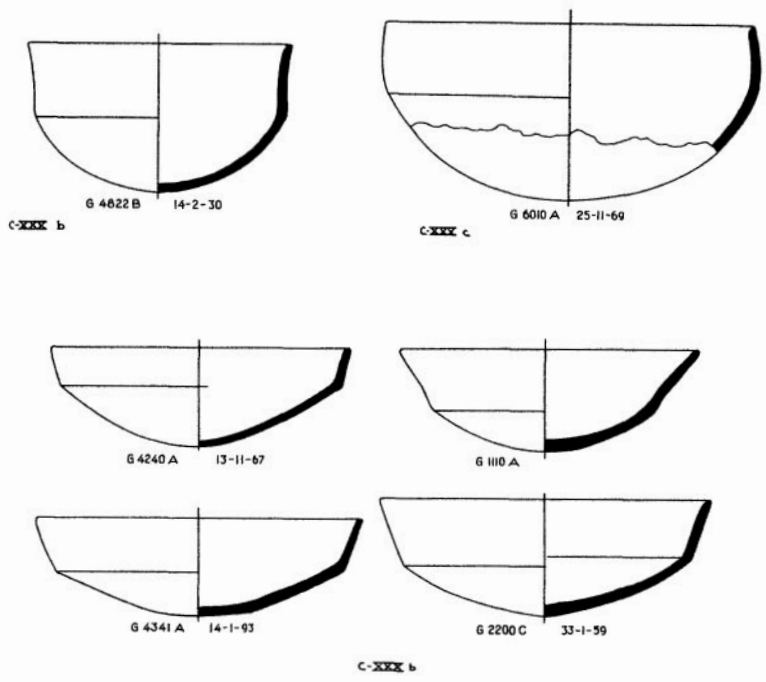

Fig. 108

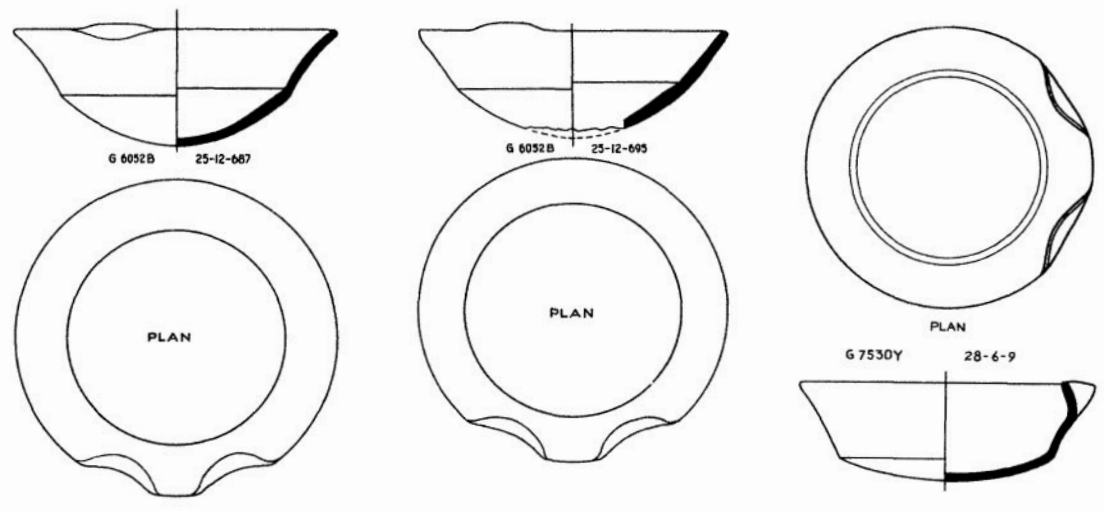

Fig. 109

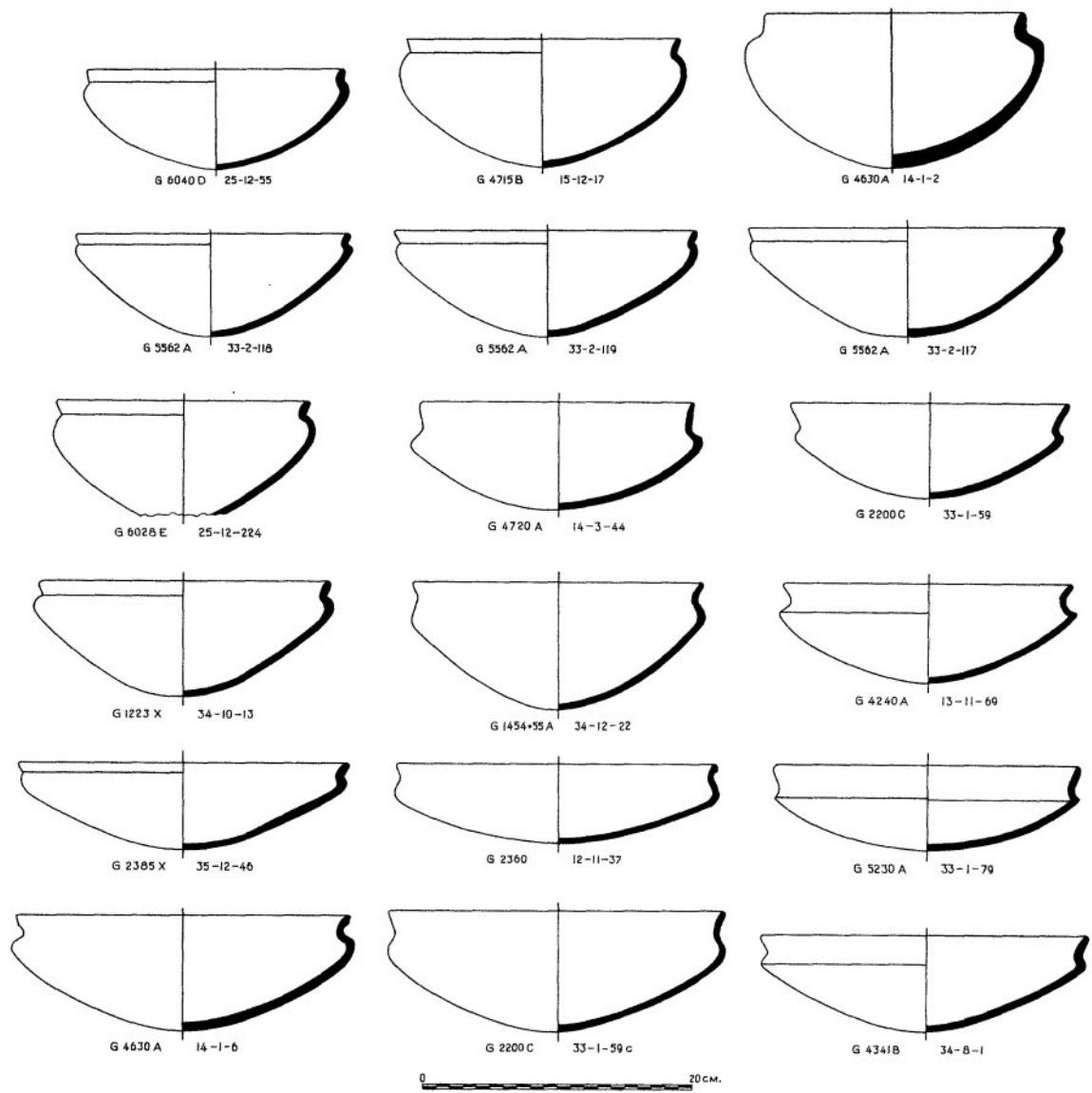

Fig. 110

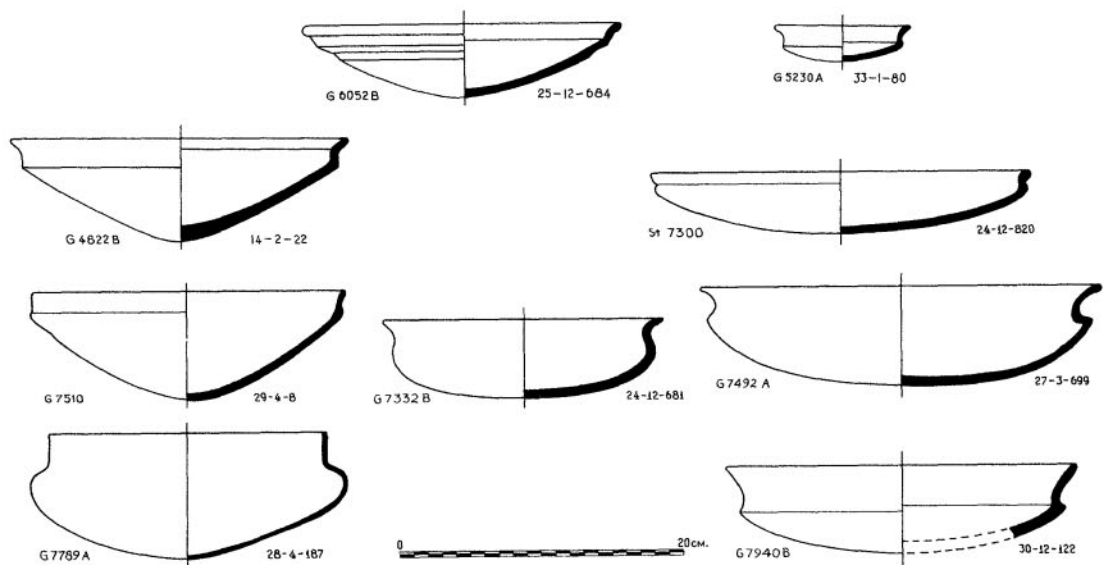

Fig. 111

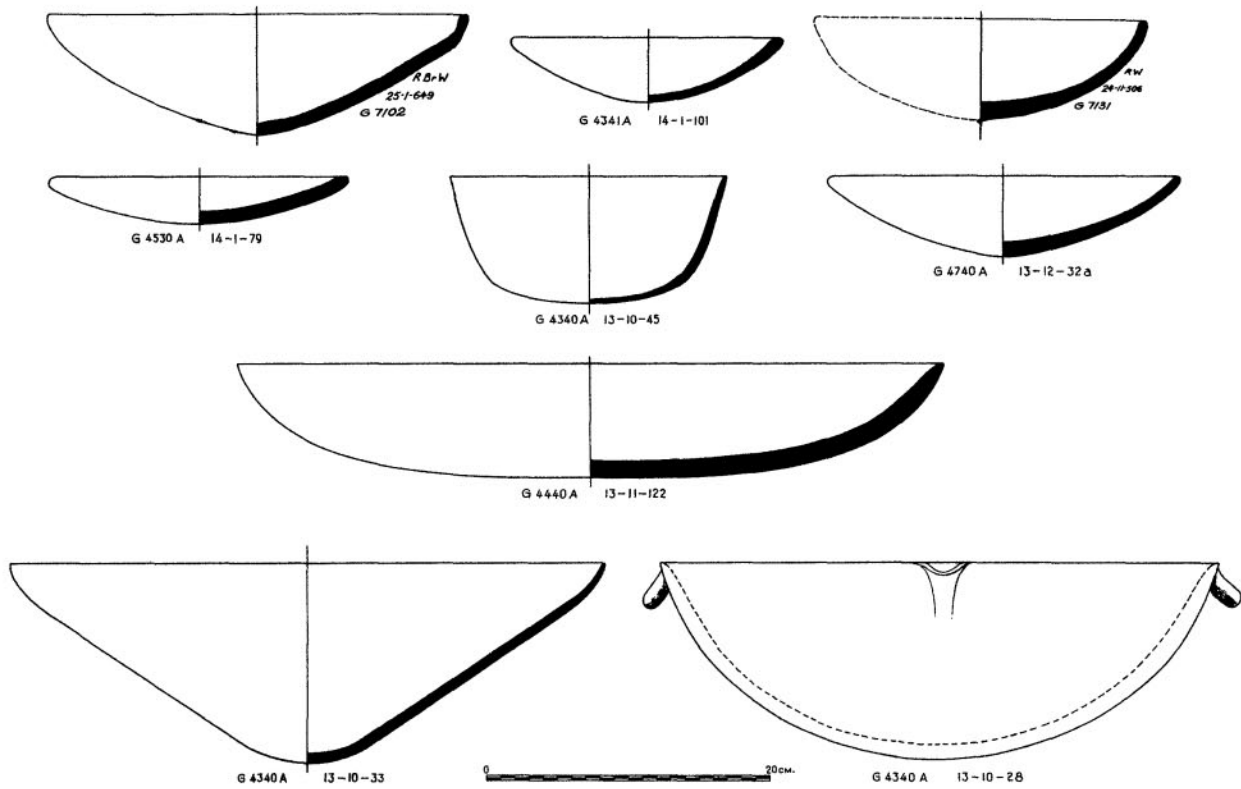

Fig. 112

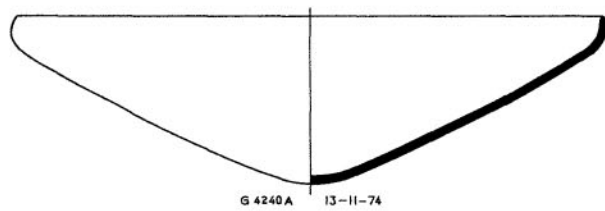

Fig. 113

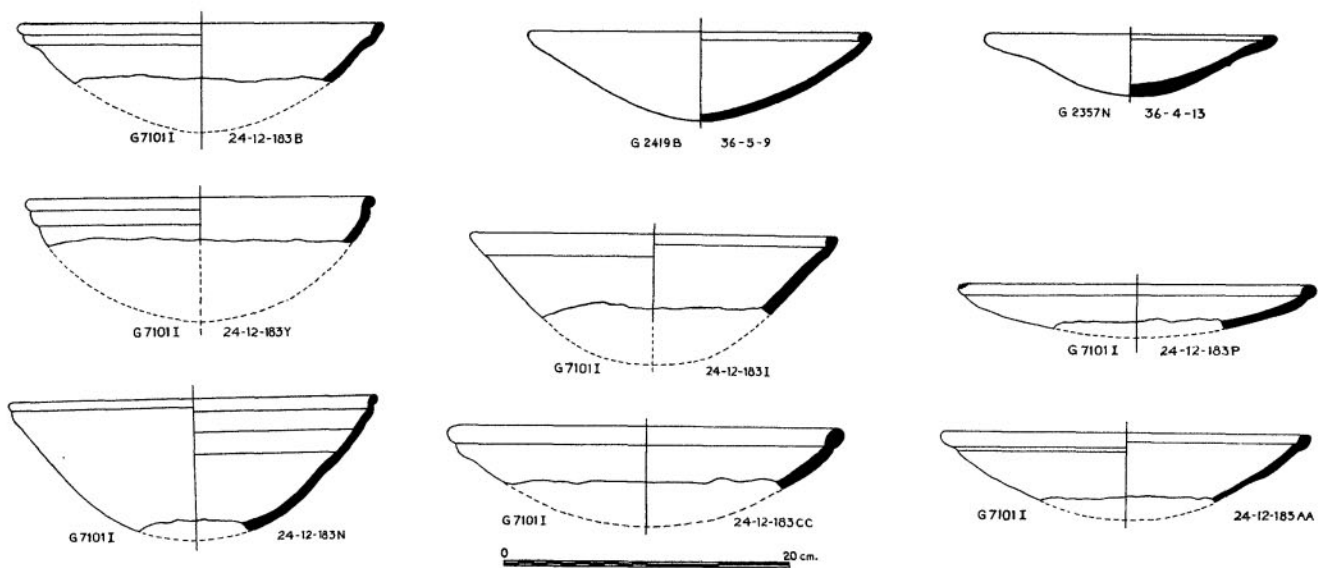

Fig. 114

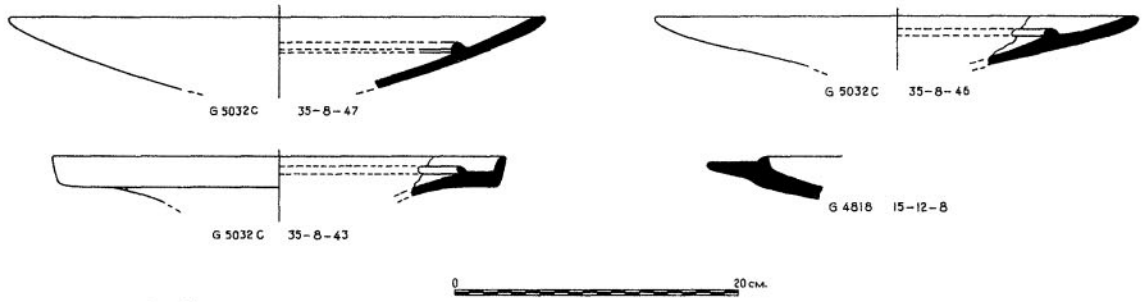

Fig. 115

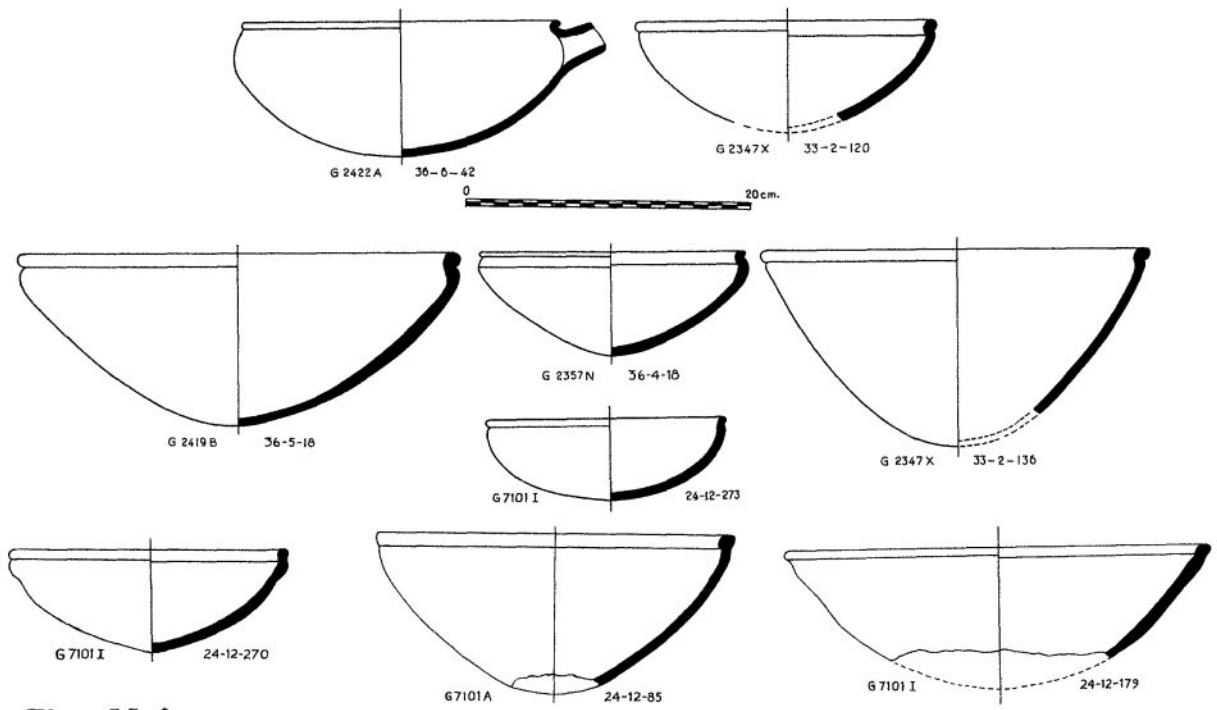

Fig. 116

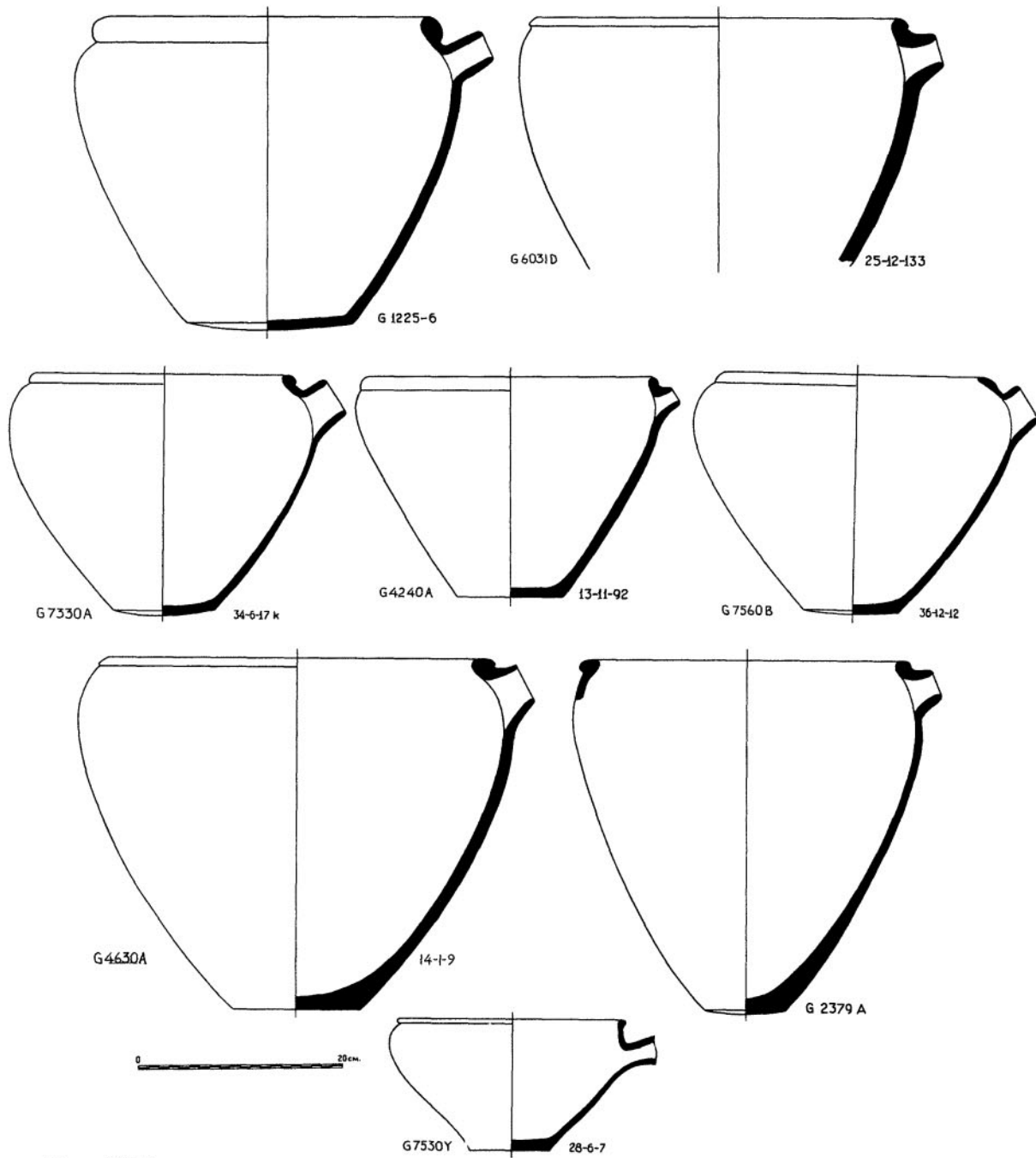

Fig. 117

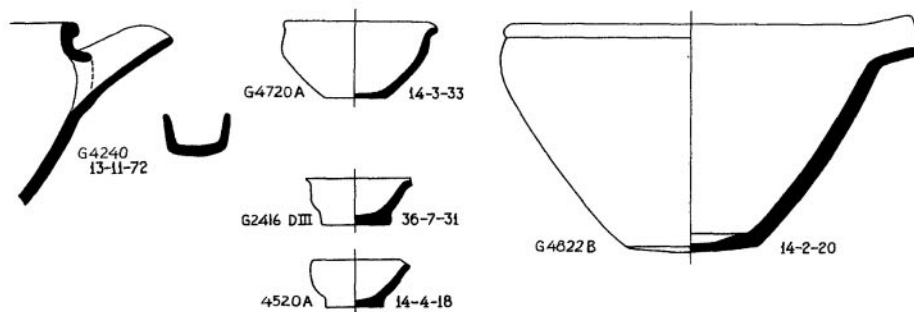

Fig. 118

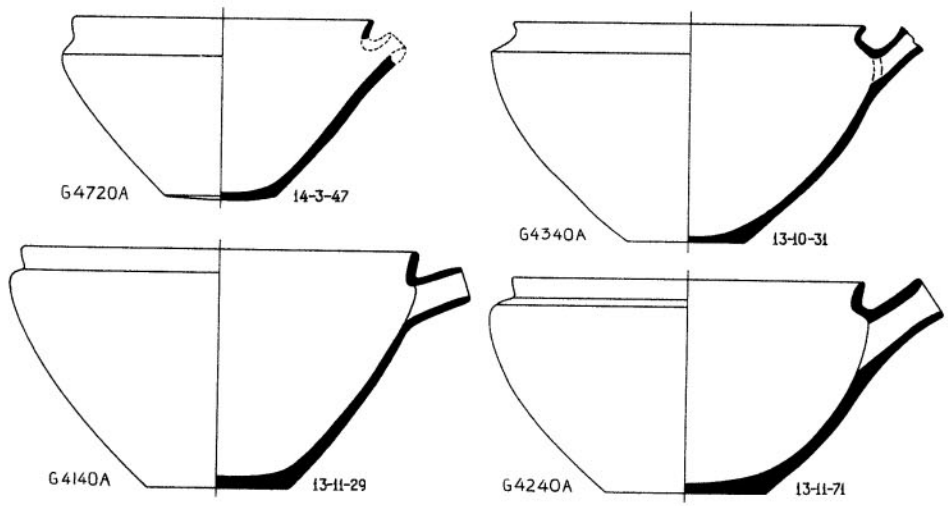

Fig. 119

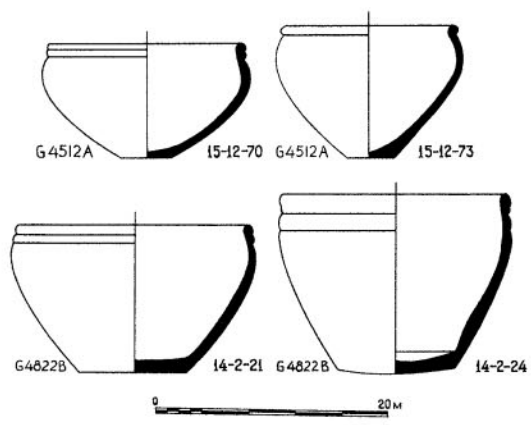

Fig. 120

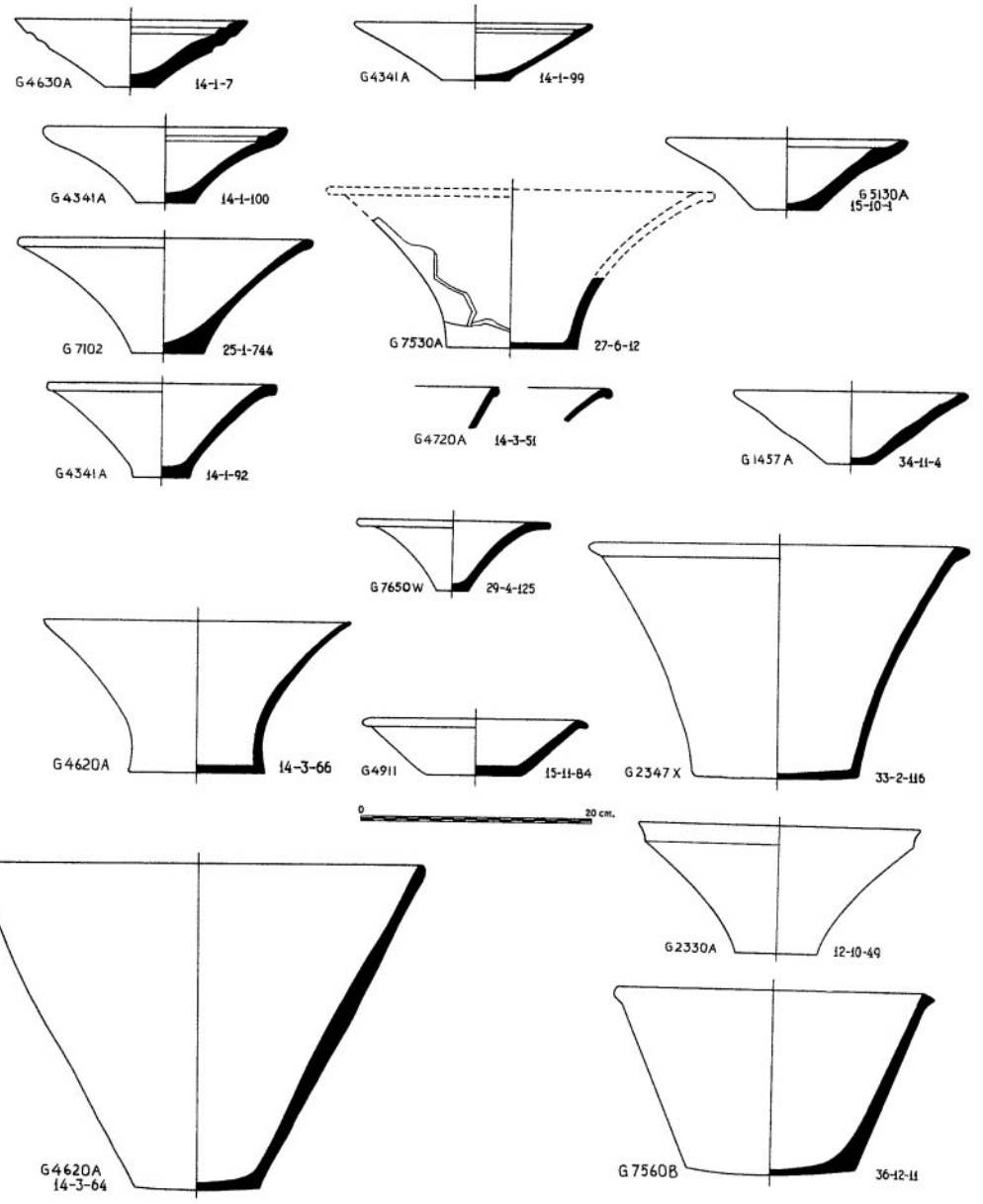

Fig. 121

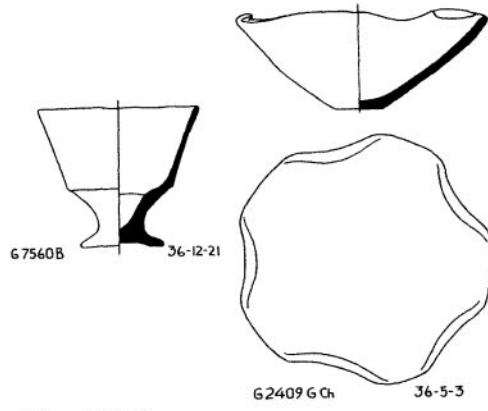

Fig. 122

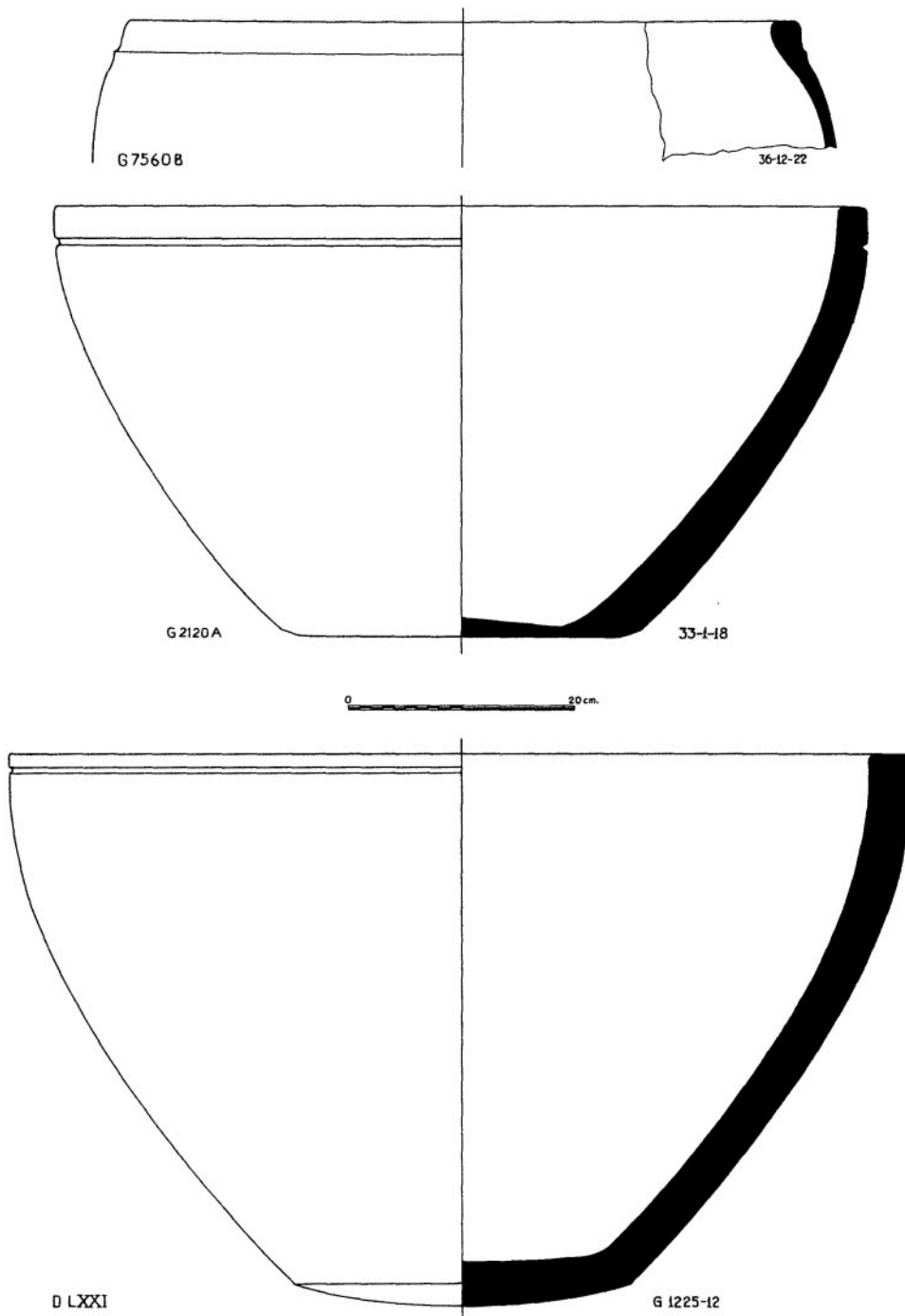

Fig. 123

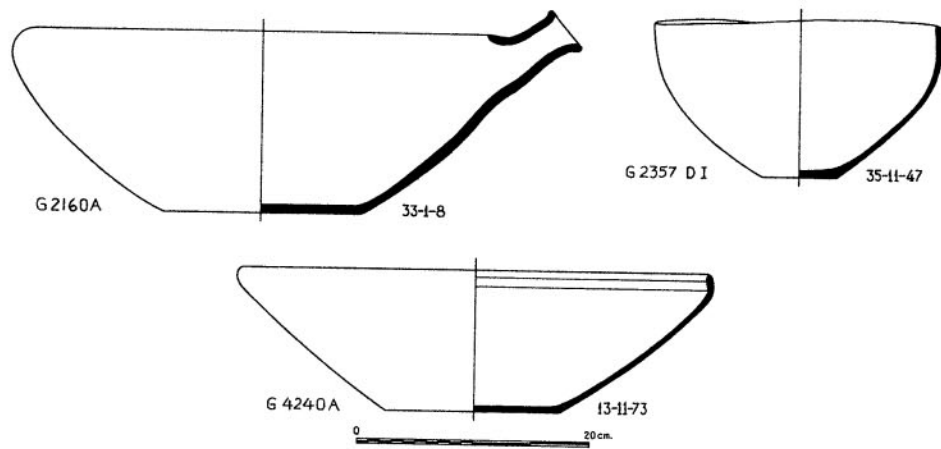

Fig. 124

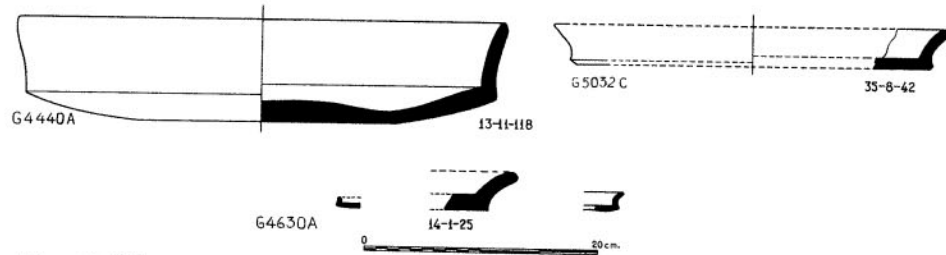

Fig. 125

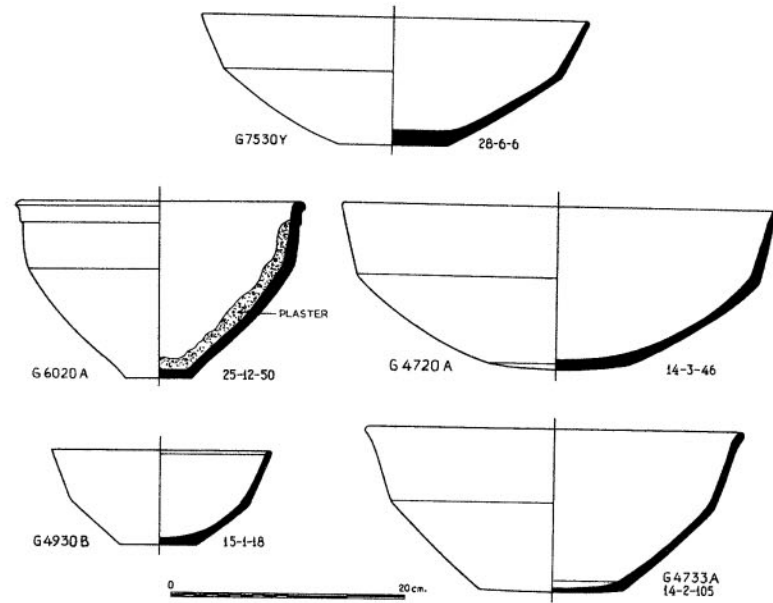

Fig. 126

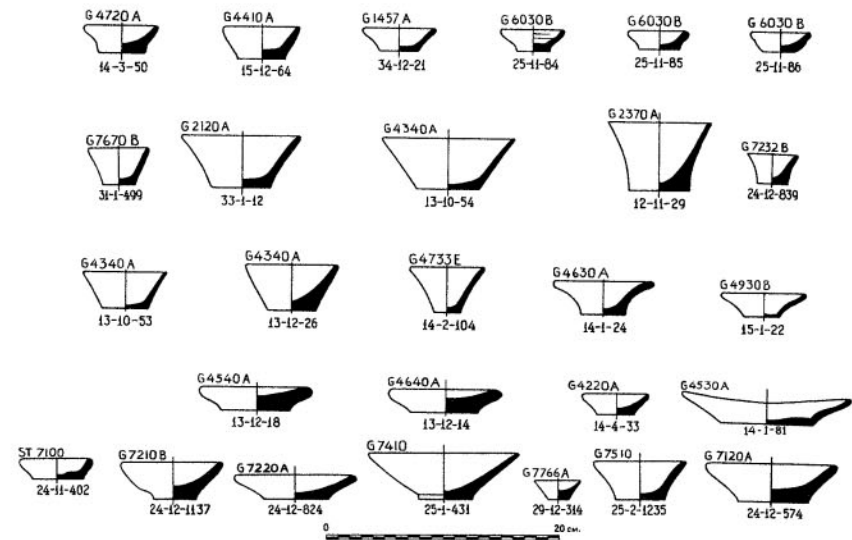

Fig. 127

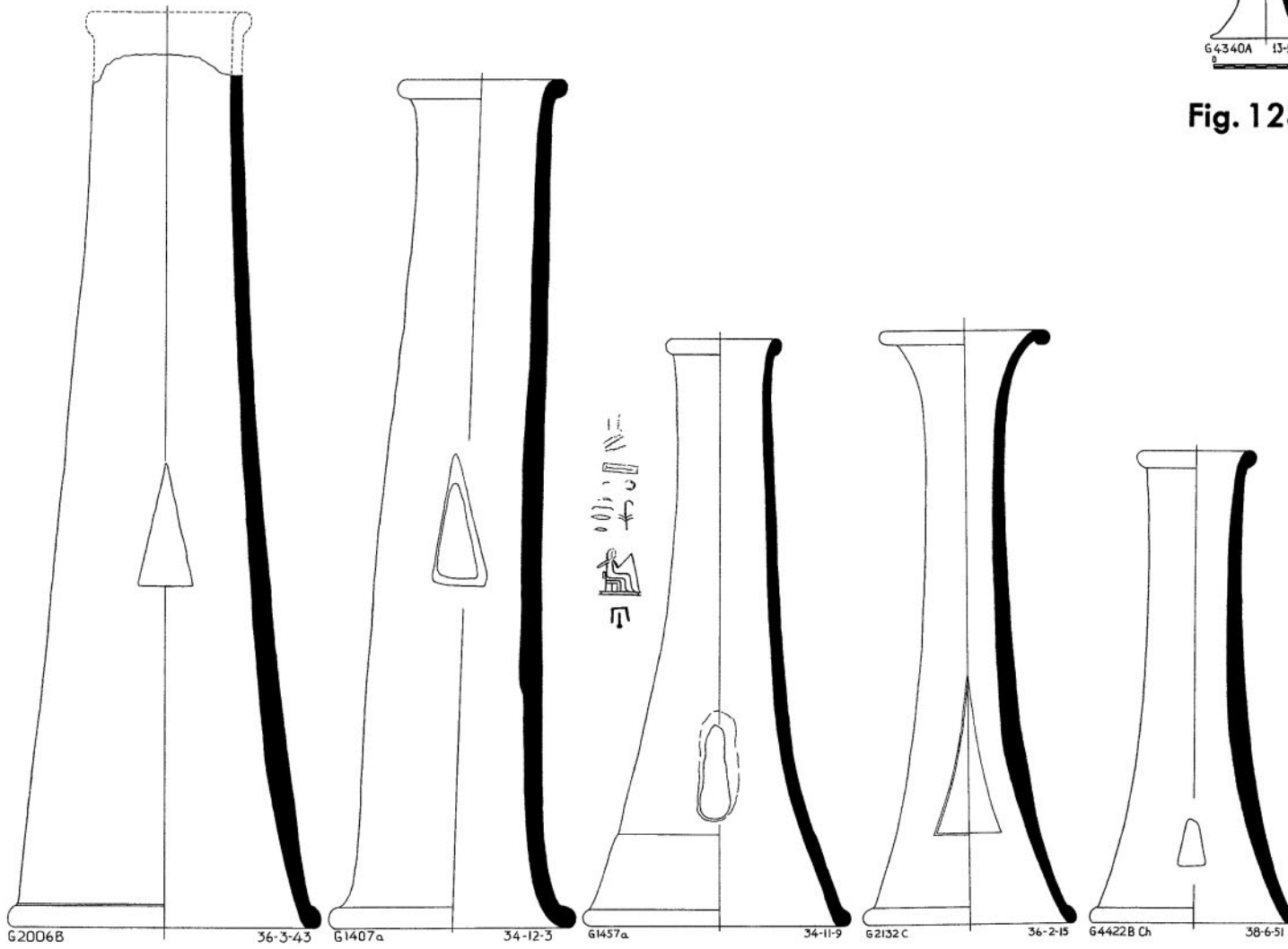

Fig. 129

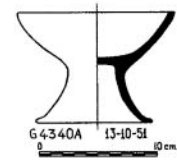

Fig. 128

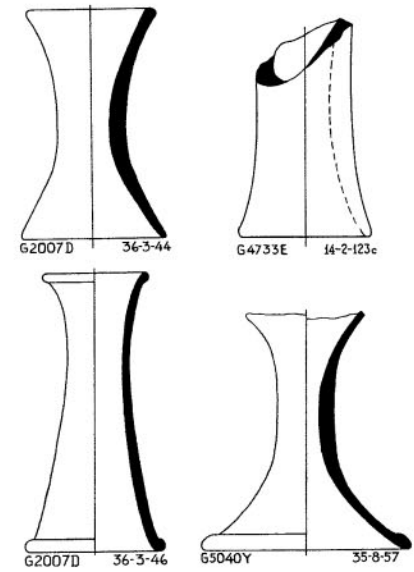

Fig. 130

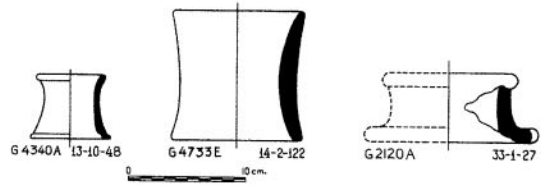

Fig. 131

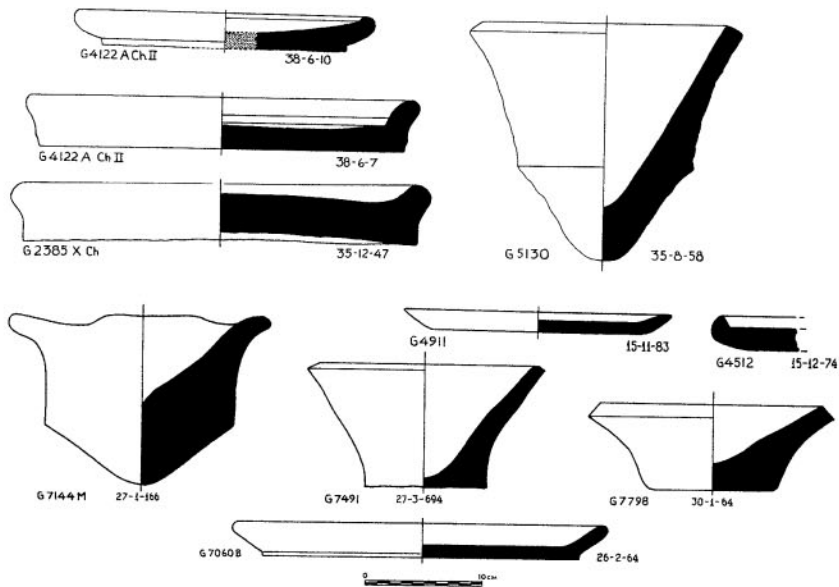

Fig. 132

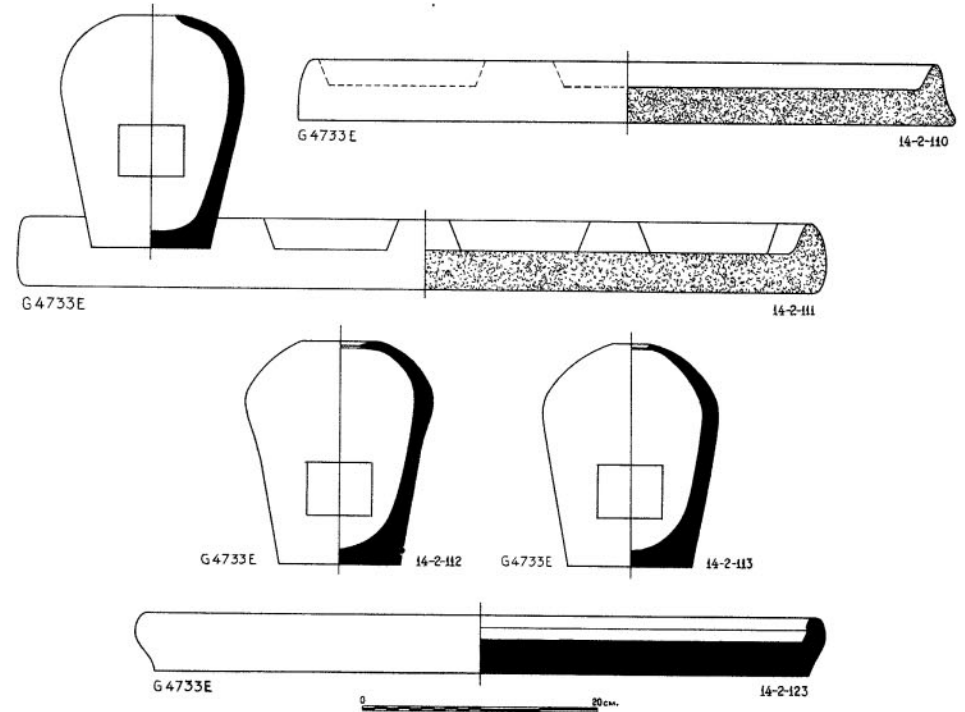
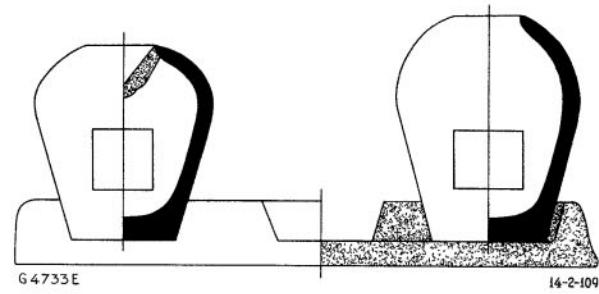

Fig. 133

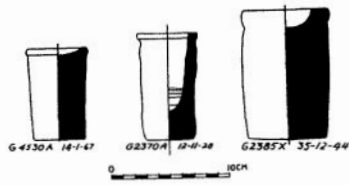

Fig. 134

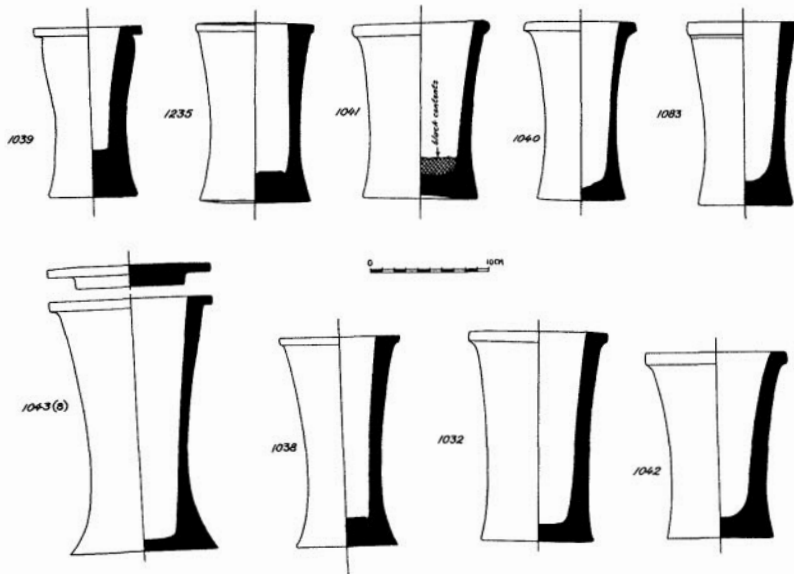

Fig. 135

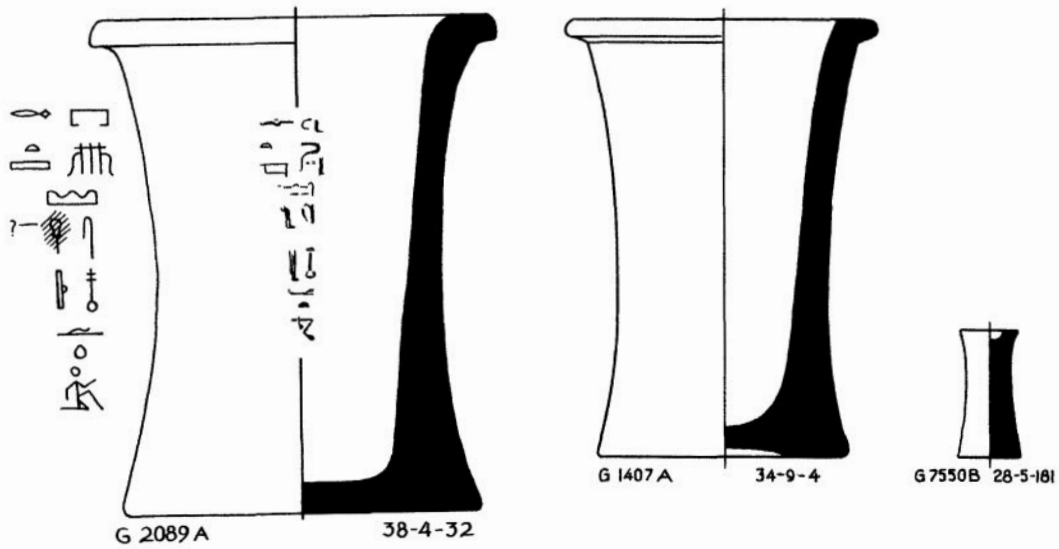

Fig. 136

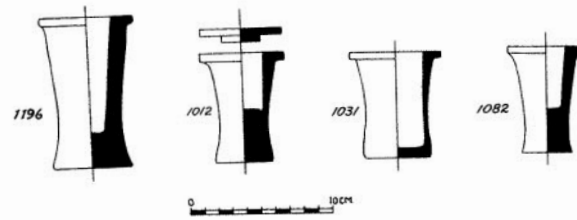

Fig. 137

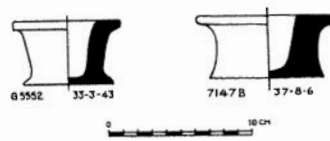

Fig. 138

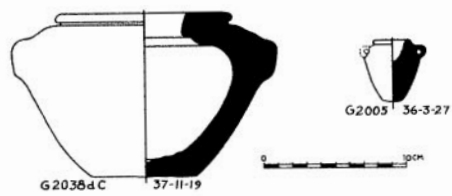

Fig. 139

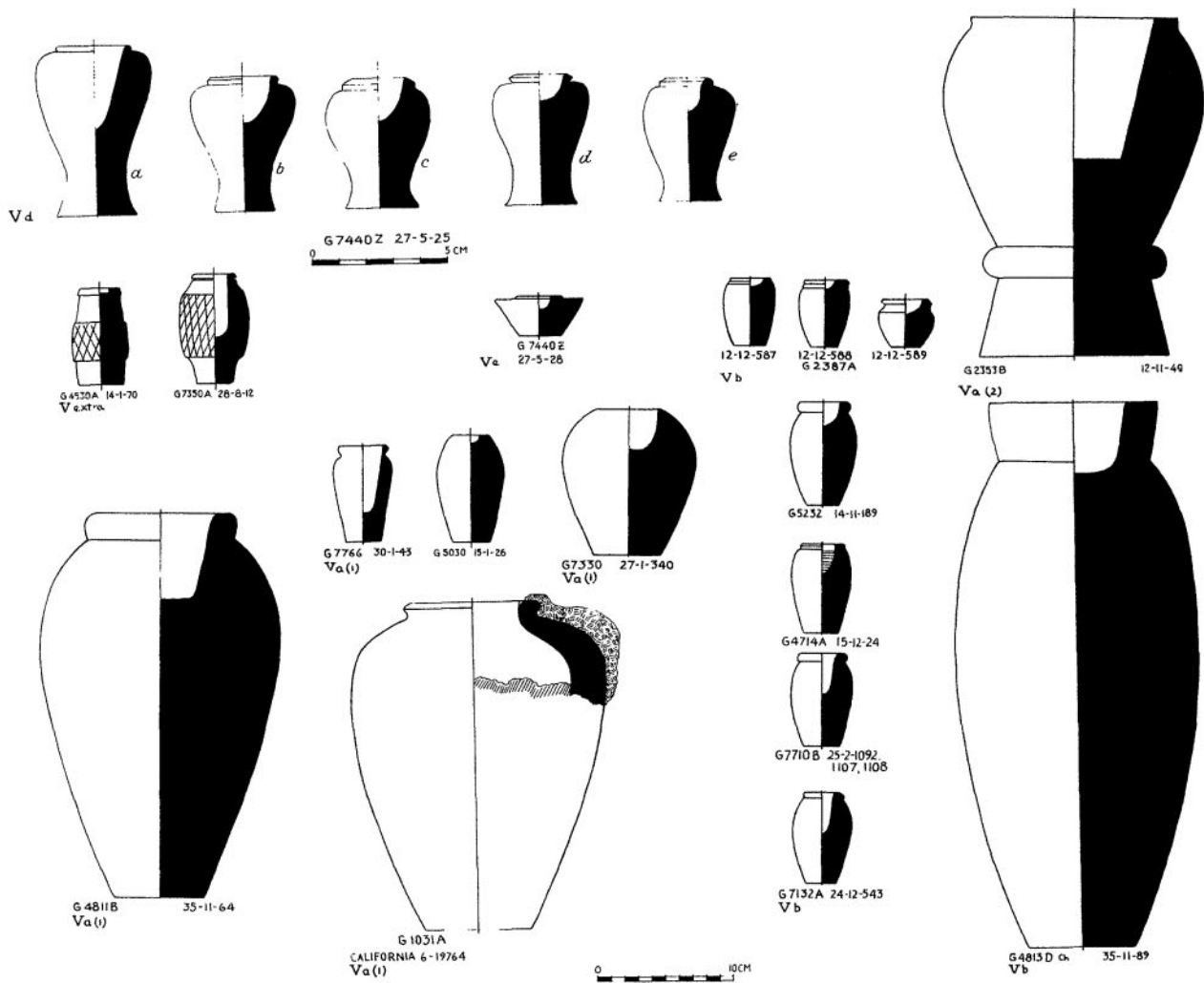

Fig. 140

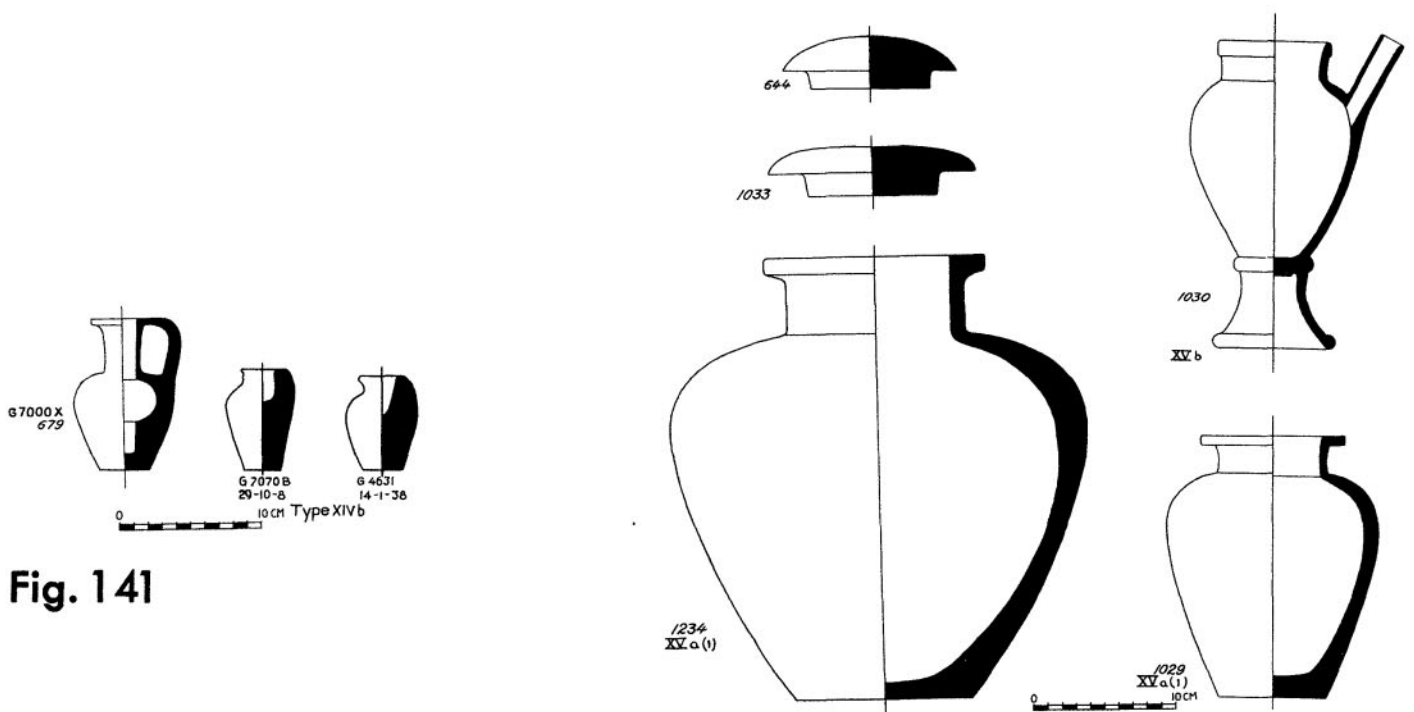

Fig. 141

Fig. 142

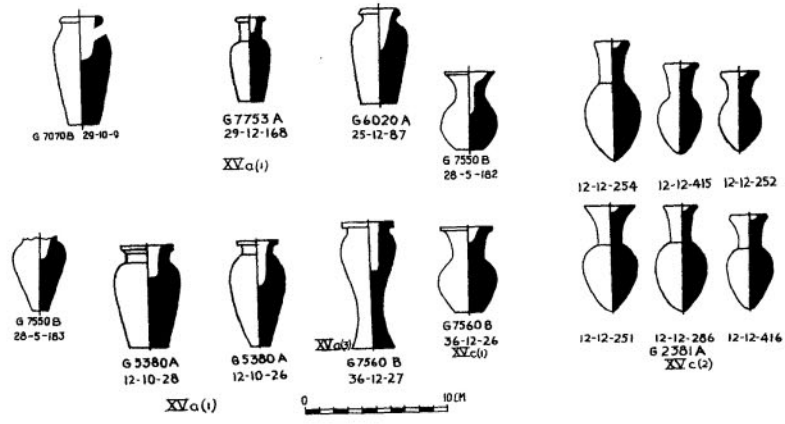

Fig. 143

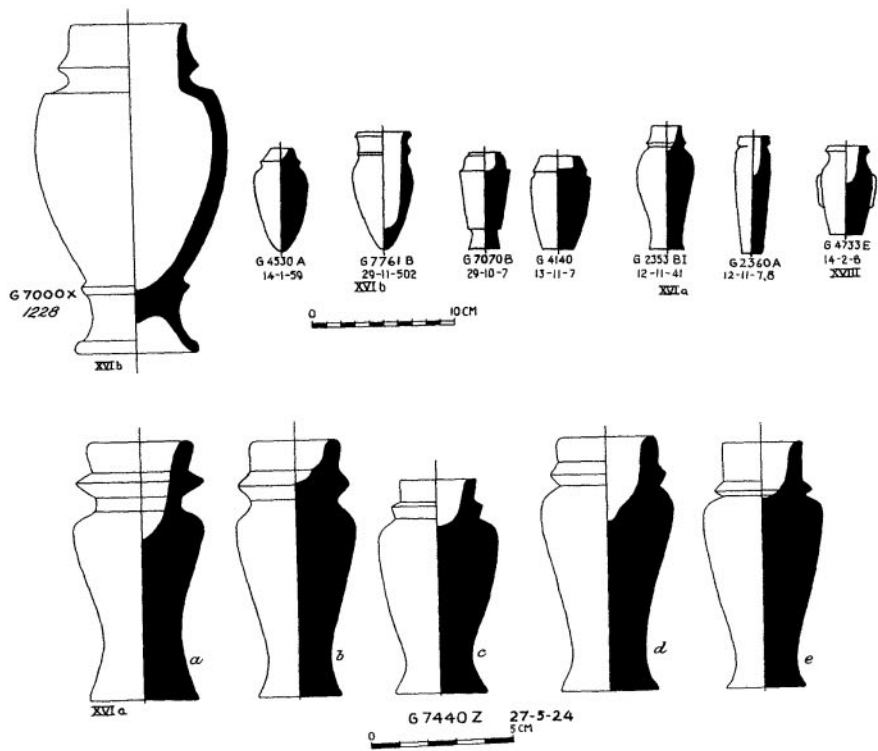

Fig. 144

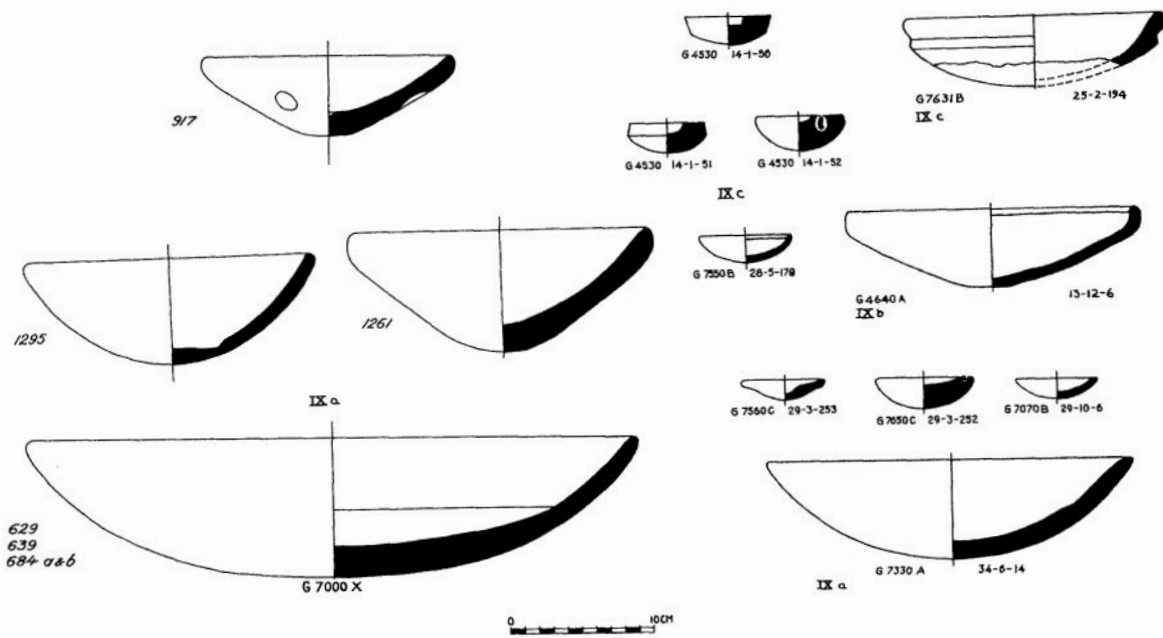

Fig. 145

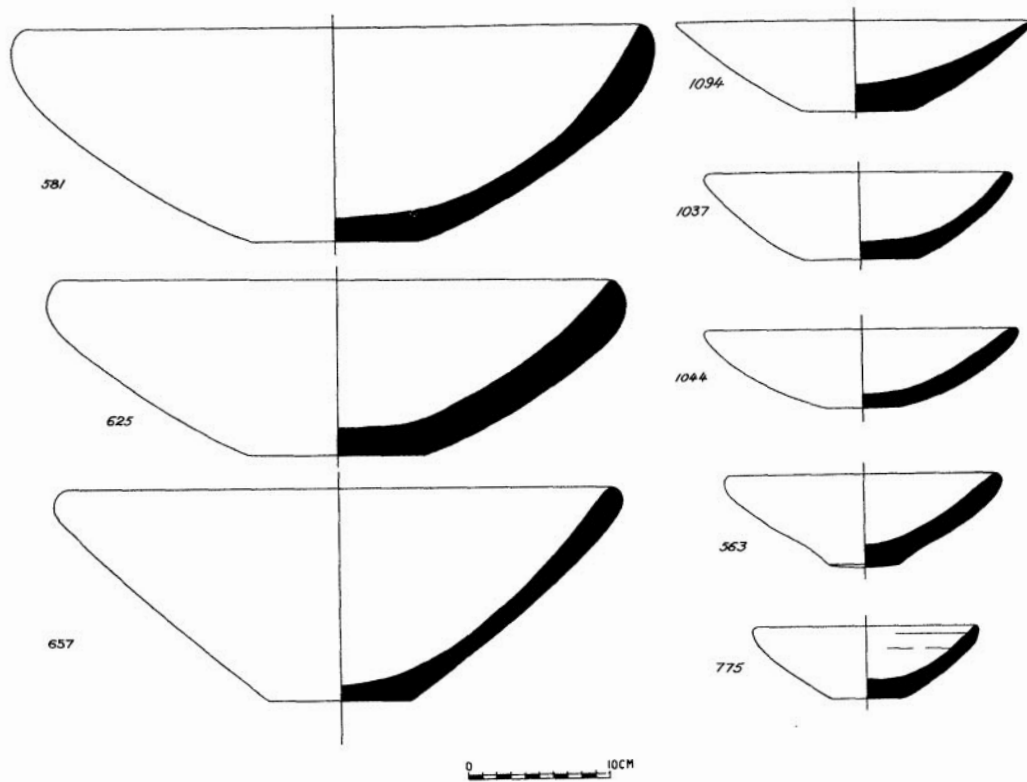

Fig. 146

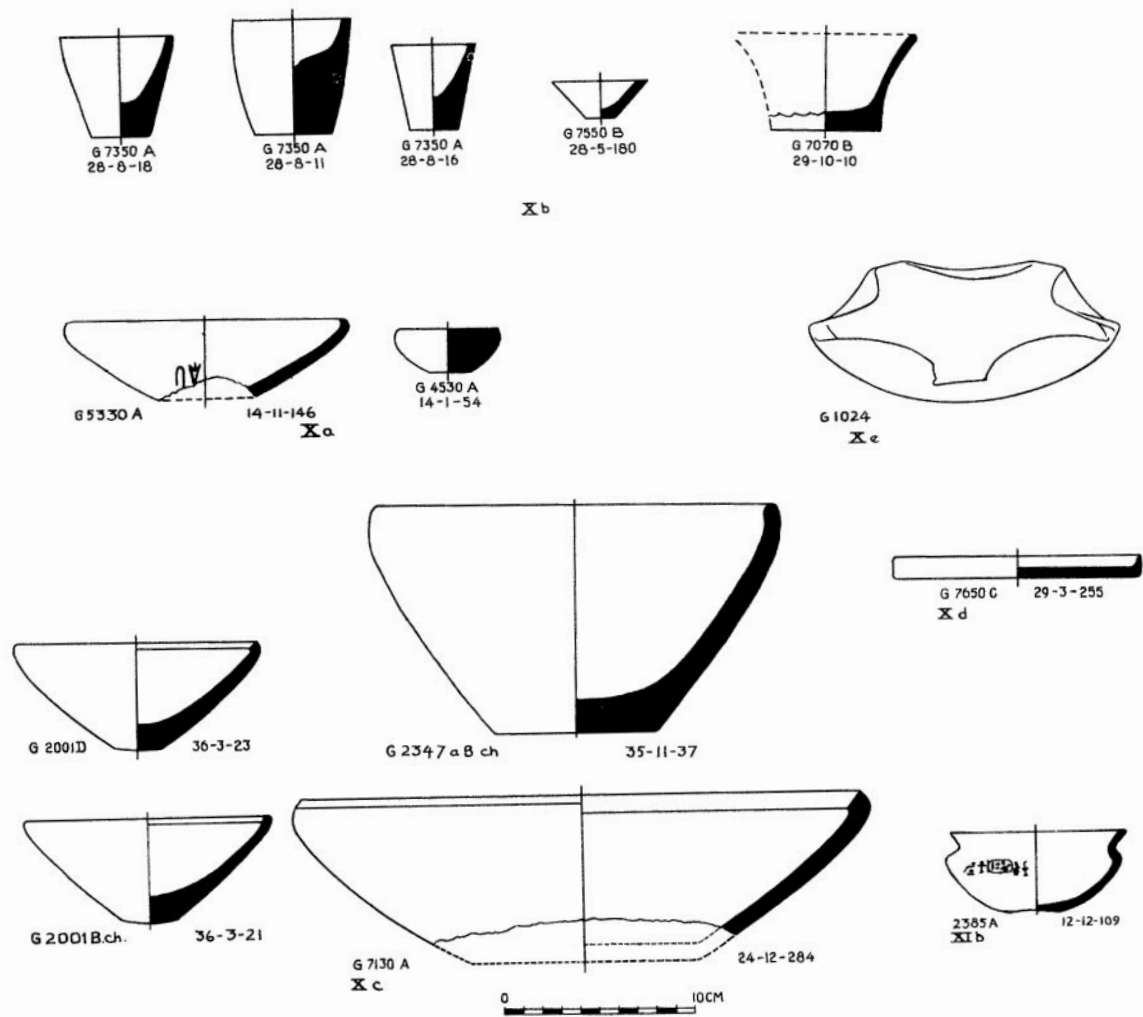

Fig. 147

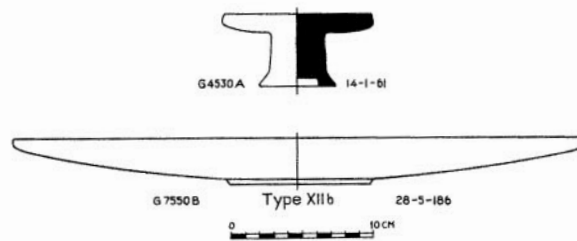

Fig. 148