

PLANS, PLATES AND FIGURES

MAP OF CEMETERY G 7000

Scale 0 50 M.

N

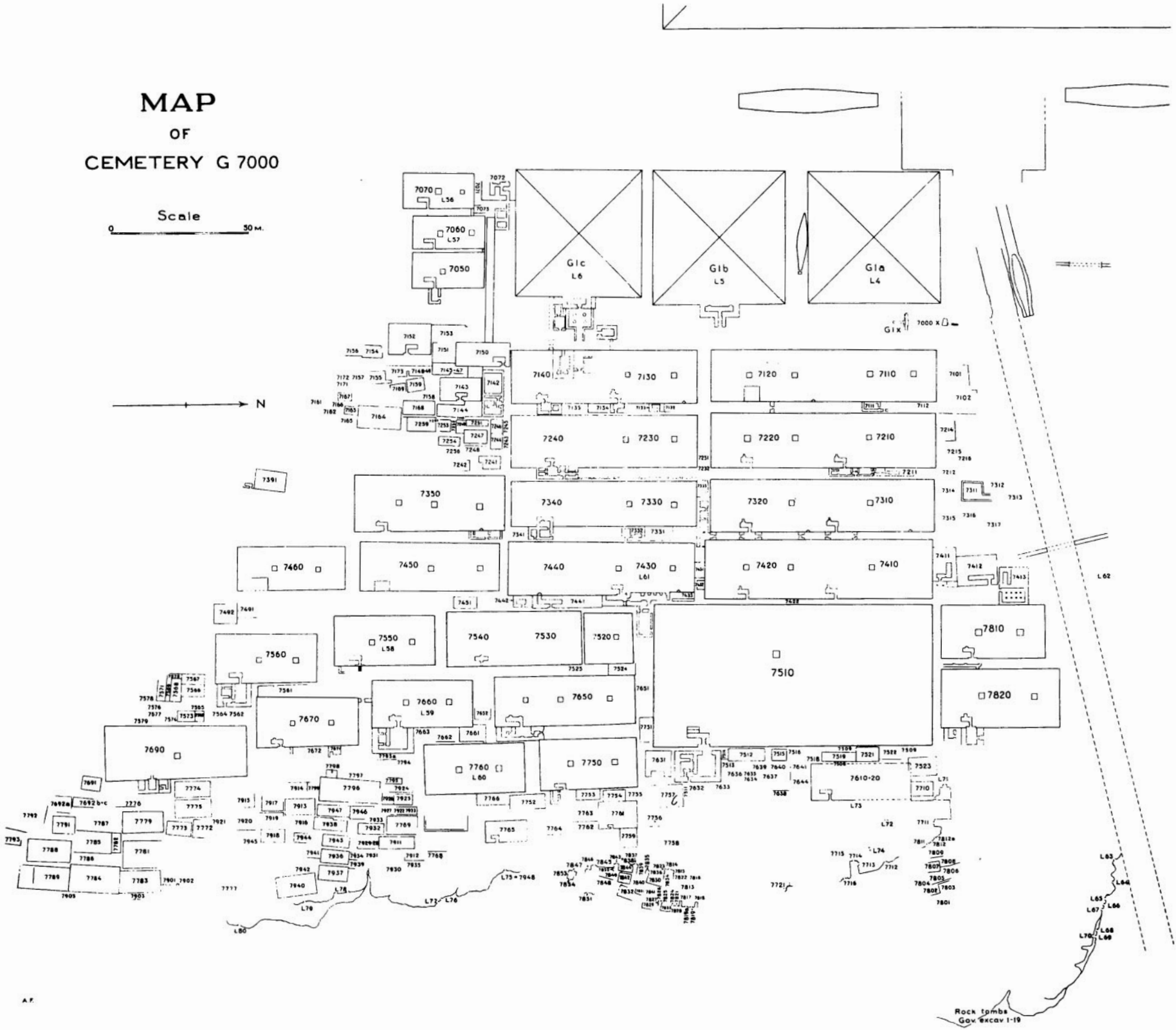

Plan A. Map of Cemetery 7000.

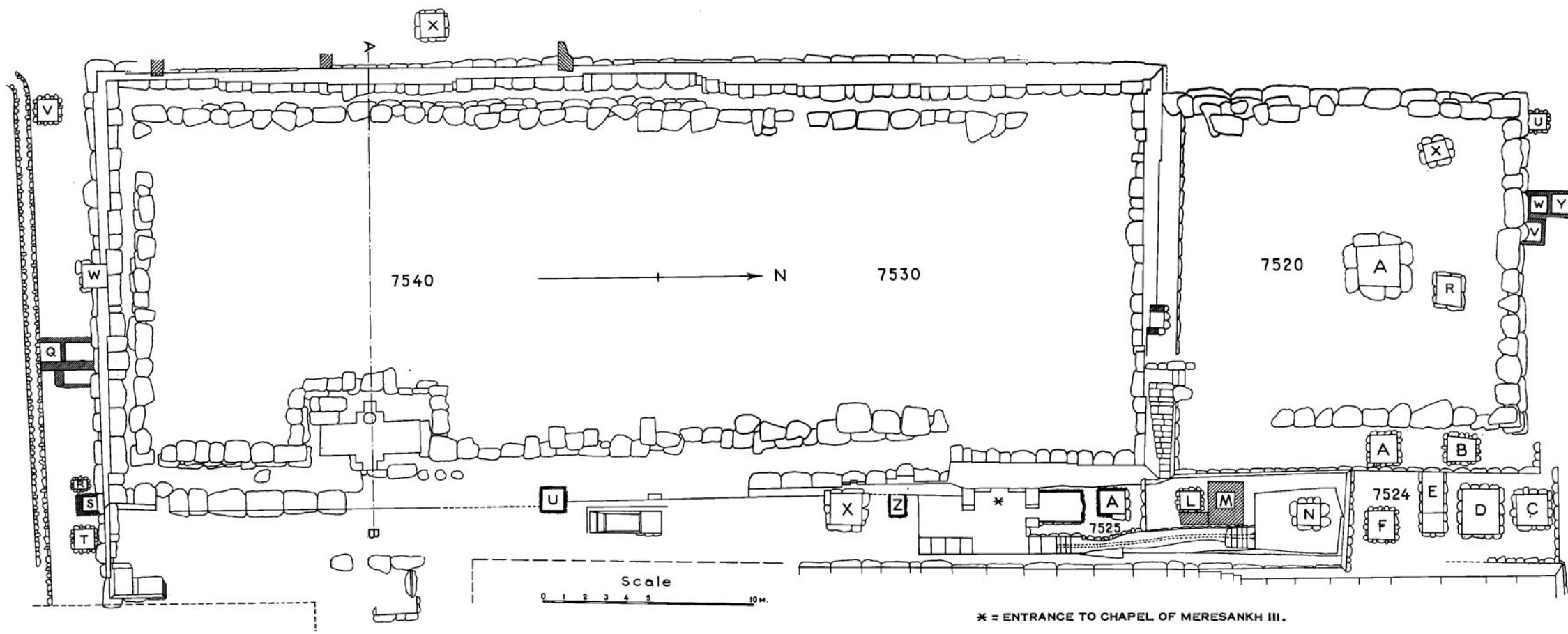

Plan B. Plan of G 7520-7540.

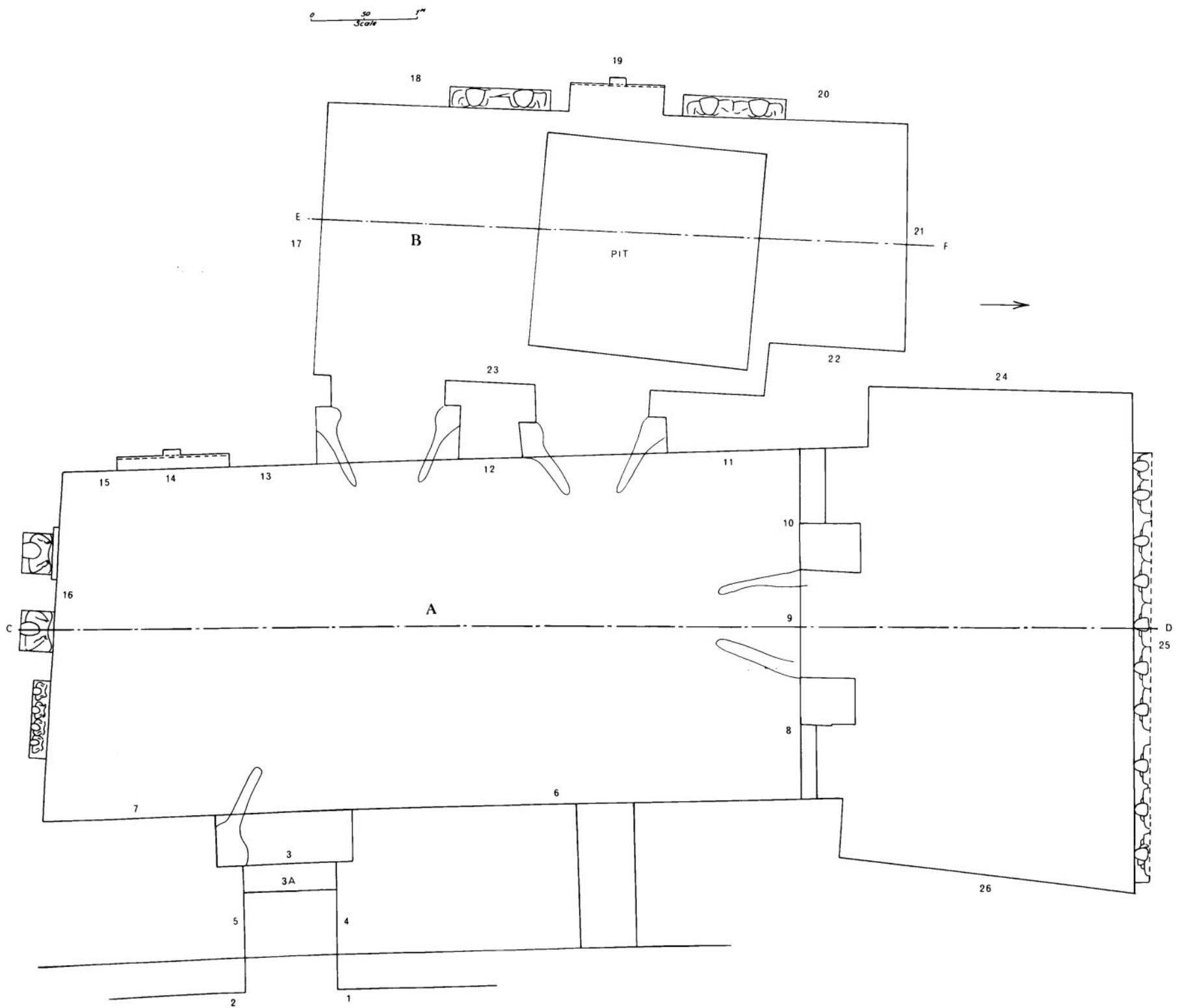

Plan C. Plan of Chambers, G 7530 sub.

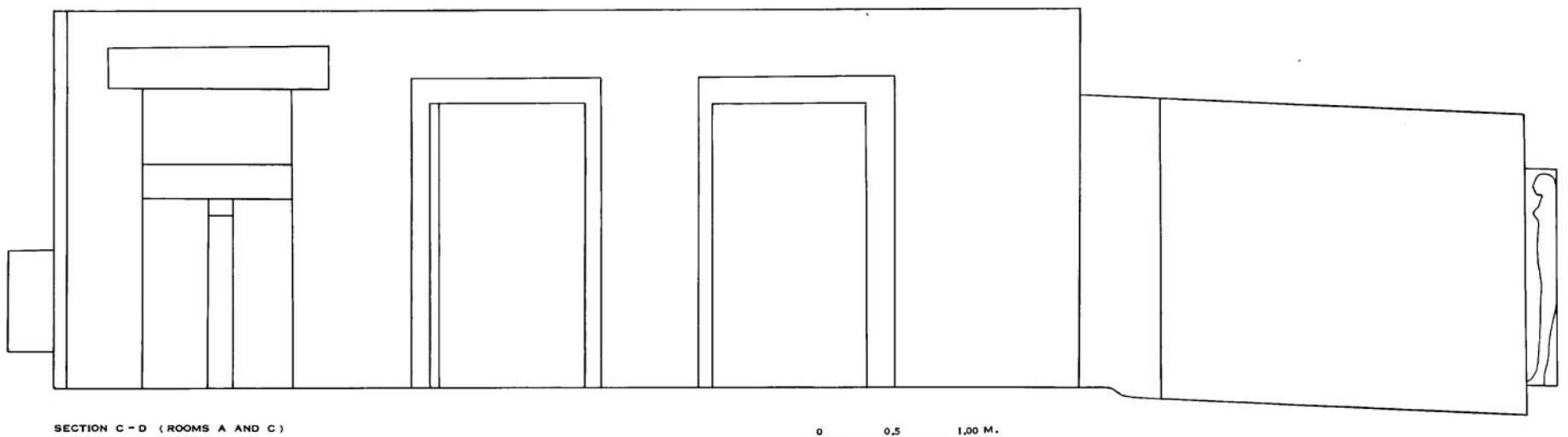

Plan D. Elevation of Main Room.

G 7530 A

Sectional Elevation through E-F

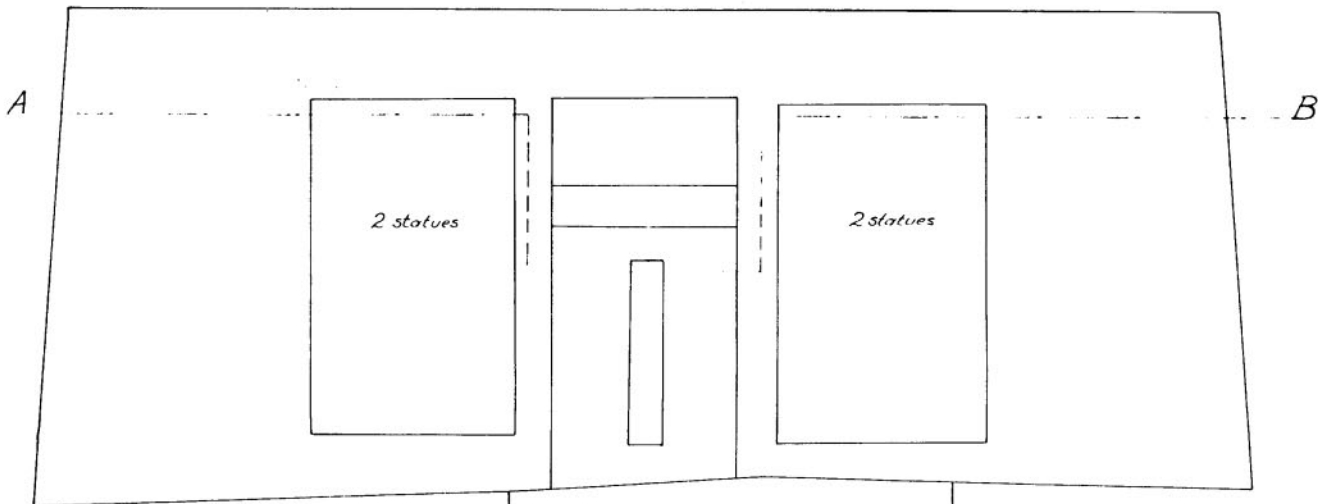

0 50 1^m
Scale

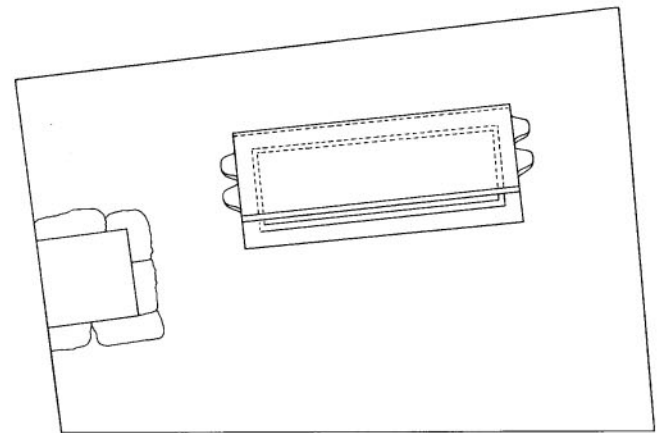

PLAN OF BURIAL CHAMBER 0 0.5 1.00M.

Plan F. Plan of Burial Chamber.

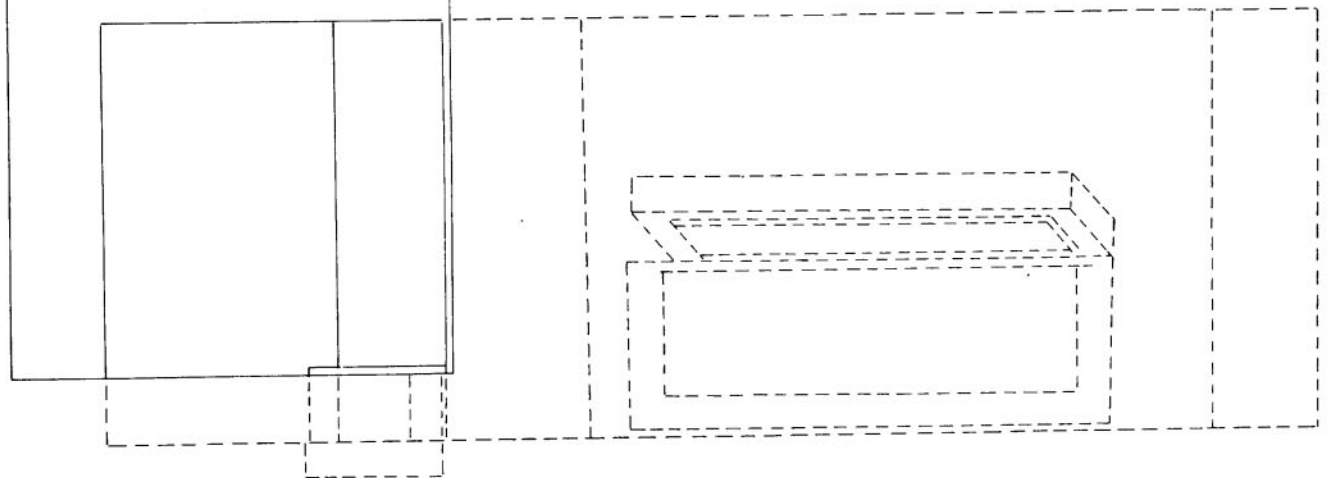

Plan E. Section of Offering Room and Burial Chamber.